

## Features

- 1 & 2 Pole relay range**  
**40.31 - 1 Pole 10 A (3.5 mm pin pitch)**  
**40.51 - 1 Pole 10 A (5 mm pin pitch)**  
**40.52 - 2 Pole 8 A (5 mm pin pitch)**

**PCB mount**

- direct or via PCB socket

**35 mm rail mount**

- via screw and screwless sockets

- DC coils (standard or sensitive) & AC coils
- Cadmium Free contact material
- 8 mm, 6 kV (1.2/50  $\mu$ s) isolation, coil-contacts
- UL Listing (certain relay/socket combinations)
- Flux proof: RT II standard, (RT III option)
- 95 series sockets
- Coil EMC suppression
- Timer accessories 86 series

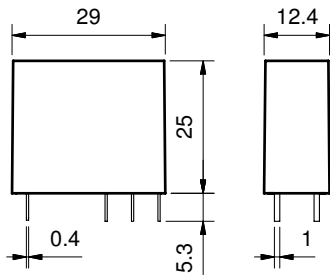

FOR UL HORSEPOWER AND PILOT DUTY RATINGS  
 SEE "General technical information" page V

### 40.31



- 3.5 mm contact pin pitch
- 1 Pole 10 A
- PCB or 95 series sockets

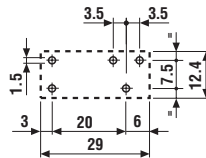
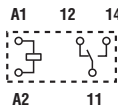

Copper side view

### 40.51



- 5 mm contact pin pitch
- 1 Pole 10 A
- PCB or 95 series sockets

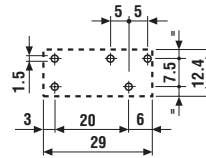
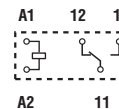

Copper side view

### 40.52



- 5 mm contact pin pitch
- 2 Pole 8 A
- PCB or 95 series sockets

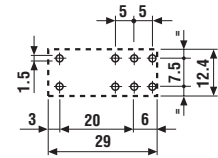
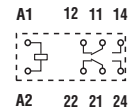

Copper side view

#### Contact specification

Contact configuration	1 CO (SPDT)	1 CO (SPDT)	2 CO (DPDT)
Rated current/Maximum peak current A	10/20	10/20	8/15
Rated voltage/Maximum switching voltage V AC	250/400	250/400	250/400
Rated load AC1 VA	2,500	2,500	2,000
Rated load AC15 (230 V AC) VA	500	500	400
Single phase motor rating (230 V AC) kW	0.37	0.37	0.3
Breaking capacity DC1: 30/110/220 V A	10/0.3/0.12	10/0.3/0.12	8/0.3/0.12
Minimum switching load mW (V/mA)	300 (5/5)	300 (5/5)	300 (5/5)
Standard contact material	AgNi	AgNi	AgNi

#### Coil specification

Nominal voltage (U <sub>N</sub> )	V AC (50/60 Hz)	6 - 12 - 24 - 48 - 60 - 110 - 120 - 230 - 240		
	V DC	5 - 6 - 7 - 9 - 12 - 14 - 18 - 21 - 24 - 28 - 36 - 48 - 60 - 90 - 110 - 125		
Rated power AC/DC/sens. DC VA (50 Hz)/W/W		1.2/0.65/0.5	1.2/0.65/0.5	1.2/0.65/0.5
Operating range	AC	(0.8...1.1)U <sub>N</sub>		(0.8...1.1)U <sub>N</sub>
	DC/sens. DC	(0.73...1.5)U <sub>N</sub> /(0.73...1.75)U <sub>N</sub>		(0.73...1.5)U <sub>N</sub> /(0.73...1.75)U <sub>N</sub>
Holding voltage AC/DC		0.8 U <sub>N</sub> /0.4 U <sub>N</sub>		0.8 U <sub>N</sub> /0.4 U <sub>N</sub>
Must drop-out voltage AC/DC		0.2 U <sub>N</sub> /0.1 U <sub>N</sub>		0.2 U <sub>N</sub> /0.1 U <sub>N</sub>

#### Technical data

Mechanical life AC/DC	cycles	10 · 10 <sup>6</sup> /20 · 10 <sup>6</sup>	10 · 10 <sup>6</sup> /20 · 10 <sup>6</sup>	10 · 10 <sup>6</sup> /20 · 10 <sup>6</sup>
Electrical life at rated load AC1	cycles	200 · 10 <sup>3</sup>	200 · 10 <sup>3</sup>	100 · 10 <sup>3</sup>
Operate/release time	ms	7/3 - (12/4 sensitive)		7/3 - (12/4 sensitive)
Insulation between coil and contacts (1.2/50 $\mu$ s)	kV	6 (8 mm)		
Dielectric strength between open contacts V AC		1,000		
Ambient temperature range	°C	-40...+85		
Environmental protection		RT II**		

#### Approvals (according to type)



\*\* See general technical information "Guidelines for automatic flow solder processes" page II .

## Features

**40.61** - 1 Pole 16 A (5 mm pin pitch)  
**40.xx.6** - Bistable versions of the 40.31, 40.51, 40.52 & 40.61 relays

### PCB mount

- direct or via PCB socket

### 35 mm rail mount

- via screw and screwless sockets

- DC coils & AC coils
- Cadmium Free option available
- 8 mm, 6 kV (1.2/50  $\mu$ s) isolation, coil-contacts
- UL Listing (certain 40.61 relay/socket combinations)
- Flux proof: RT II standard, (RT III option)
- 95 series sockets
- Coil EMC suppression
- Timer accessories 86 series

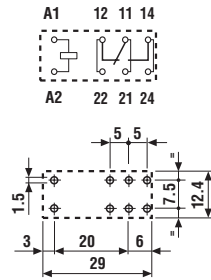
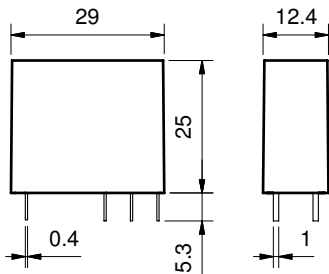

Copper side view

FOR UL HORSEPOWER AND PILOT DUTY RATINGS  
 SEE "General technical information" page V

Contact specification			
Contact configuration		1 CO (SPDT)	
Rated current/Maximum peak current	A	16/30*	
Rated voltage/Maximum switching voltage V AC		250/400	
Rated load AC1	VA	4,000	
Rated load AC15 (230 V AC)	VA	750	
Single phase motor rating (230 V AC)	kW	0.55	
Breaking capacity DC1: 30/110/220 V	A	16/0.3/0.12	
Minimum switching load	mW (V/mA)	500 (10/5)	
Standard contact material		AgCdO	
Coil specification			
Nominal voltage ( $U_N$ )	V AC (50/60 Hz)	6-12-24-48-60-110-120-230-240	5 - 6 - 12 - 24 - 48 - 110
	V DC	***See table	5 - 6 - 12 - 24 - 48 - 110
Rated power AC/DC/sens. DC	VA (50 Hz)/W/W	1.2/0.65/0.5	1.0/1.0/—
Operating range	AC	(0.8...1.1) $U_N$	(0.8...1.1) $U_N$
	DC/sens. DC	(0.73...1.5) $U_N$ /(0.8...1.5) $U_N$	(0.8...1.1) $U_N$ /—
Holding voltage	AC/DC	0.8 $U_N$ / 0.4 $U_N$	—
Must drop-out voltage	AC/DC	0.2 $U_N$ / 0.1 $U_N$	—
Technical data			
Mechanical life AC/DC	cycles	10 · 10 <sup>6</sup> /20 · 10 <sup>6</sup>	See relays
Electrical life at rated load AC1	cycles	100 · 10 <sup>3</sup>	40.31
Operate/release time	ms	7/3 - (12/4 sensitive)	40.51
Insulation between coil and contacts (1.2/50 $\mu$ s)	kV	6 (8 mm)	40.52
Dielectric strength between open contacts V AC		1,000	40.61
Ambient temperature range	°C	-40...+85	Min. impulse duration
Environmental protection		RT II**	≥ 20 ms

- 5 mm contact pin pitch
- 1 Pole 16 A
- PCB or 95 series sockets

Bistable version (1 coil) types:

- 40.31.6...
- 40.51.6...
- 40.52.6...
- 40.61.6...

For wiring diagrams see page 8

\* With the AgSnO<sub>2</sub> material the maximum peak current is 120 A - 5 ms on normally open contact.

\*\*\* Nominal voltage ( $U_N$ ):  
 5 - 6 - 7 - 9 - 12 - 14 - 18 - 21 - 24 - 28 - 36 - 48 - 60 - 90 - 110 - 125 V DC

Approvals (according to type)



## Features

### 1 Pole relay range

- 40.11 - 1 Pole 10 A (Flat pack)
- 40.11-2016 - 1 Pole 16 A (Flat pack)
- 40.41 - 1 Pole 10 A (Vertical)

### PCB mount

- direct or via PCB socket (40.41 version)

- DC coils
- Cadmium Free option available
- 8 mm, 6 kV (1.2/50  $\mu$ s) isolation, coil-contacts
- 40.41 - NO version available

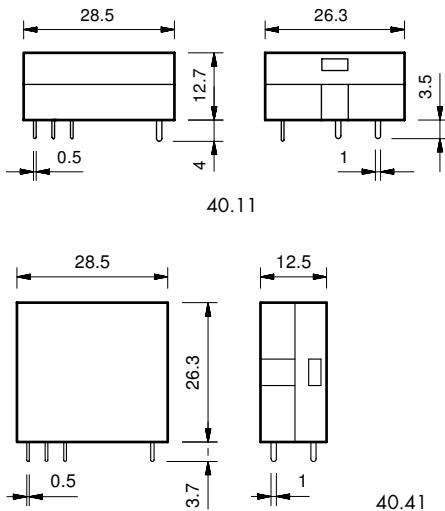

FOR UL HORSEPOWER AND PILOT DUTY RATINGS  
SEE "General technical information" page V

## 40.11



- 1 Pole 10 A
- Flat pack
- PCB mount

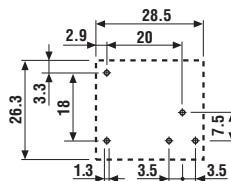
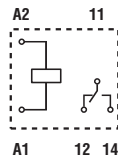

Copper side view

## 40.11-2016



- 1 Pole 16 A
- Flat pack
- PCB mount

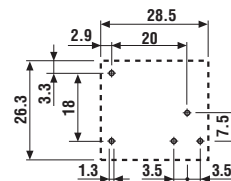
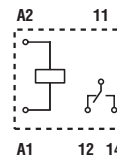

Copper side view

## 40.41



- 1 Pole 10 A
- Vertical
- PCB or 95 series socket

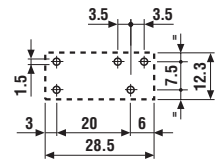
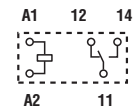

Copper side view

### Contact specification

Contact configuration	1 CO (SPDT)	1 CO (SPDT)	1 CO (SPDT)
Rated current/Maximum peak current A	10/20	16/30	10/20
Rated voltage/Maximum switching voltage V AC	250/400	250/400	250/400
Rated load AC1 VA	2,500	4,000	2,500
Rated load AC15 (230 V AC) VA	500	750	500
Single phase motor rating (230 V AC) kW	0.37	0.55	0.37
Breaking capacity DC1: 30/110/220 V A	10/0.3/0.12	16/0.3/0.12	10/0.3/0.12
Minimum switching load mW (V/mA)	300 (5/5)	500 (10/5)	300 (5/5)
Standard contact material	AgCdO	AgCdO	AgCdO

### Coil specification

Nominal voltage (U <sub>N</sub> )	V AC (50/60 Hz)	—	—	—
	V DC	6 - 12 - 24 - 48 - 60	6 - 12 - 24 - 48	6 - 12 - 24 - 48 - 60
Rated power AC/DC/sens. DC VA (50 Hz)/W/W	—/—/0.5	—/—/0.5	—/—/0.5	
Operating range	AC	—	—	—
	DC/sens. DC	—/(0.73...1.75)U <sub>N</sub>	—/(0.73...1.5)U <sub>N</sub>	—/(0.73...1.75)U <sub>N</sub>
Holding voltage AC/DC	—/0.4 U <sub>N</sub>	—/0.4 U <sub>N</sub>	—/0.4 U <sub>N</sub>	
Must drop-out voltage AC/DC	—/0.1 U <sub>N</sub>	—/0.1 U <sub>N</sub>	—/0.1 U <sub>N</sub>	

### Technical data

Mechanical life AC/DC	cycles	—/20 · 10 <sup>6</sup>	—/20 · 10 <sup>6</sup>	—/20 · 10 <sup>6</sup>
Electrical life at rated load AC1	cycles	200 · 10 <sup>3</sup>	50 · 10 <sup>3</sup>	200 · 10 <sup>3</sup>
Operate/release time	ms	12/4	12/4	12/4
Insulation between coil and contacts (1.2/50 $\mu$ s)	kV	6 (8 mm)	6 (8 mm)	6 (8 mm)
Dielectric strength between open contacts V AC		1,000	1,000	1,000
Ambient temperature range	°C	−40...+70	−40...+70	−40...+70
Environmental protection		RT I	RT I	RT I

### Approvals (according to type)



## Ordering information

Example: 40 series PCB relay, 2 CO (DPDT), 230 V AC coil.

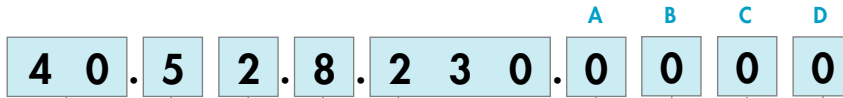

<p><b>Series</b> ———</p> <p><b>Type</b> ———</p> <p>1 = PCB - 3.5 mm pinning, flat          3 = PCB - 3.5 mm pinning          4 = PCB - 3.5 mm pinning          5 = PCB - 5 mm pinning          6 = PCB - 5 mm pinning</p> <p><b>No. of poles</b> ———</p> <p>1 = 1 pole          for: 40.11, 10 A/16 A          40.31, 10 A          40.41, 10 A          40.51, 10 A          40.61, 16 A</p> <p>2 = 2 pole          for: 40.52, 8 A</p> <p><b>Coil version</b> ———</p> <p>6 = AC/DC bistable          7 = Sensitive DC          8 = AC (50/60 Hz)          9 = DC</p> <p><b>Coil voltage</b> ———</p> <p>See coil specifications</p>	<p><b>A: Contact material</b></p> <p>0 = Standard AgNi          for 40.31/51/52,          AgCdO for 40.61          2 = AgCdO (standard          for 40.11/41)          4 = AgSnO<sub>2</sub>          5 = AgNi + Au (5 µm)</p> <p><b>B: Contact circuit</b></p> <p>0 = CO (nPDT)          3 = NO (nPST)</p>	<p><b>D: Special versions</b></p> <p>0 = Standard          1 = Wash tight (RT III)          3 = High temperature (+ 125 °C) wash tight</p> <p><b>C: Options</b></p> <p>0 = None          16 = With rated current 16 A (for 40.11)</p>
--	---	---

**Selecting features and options: only combinations in the same row are possible.**  
 Preferred selections for best availability are shown in **bold**.

Type	Coil version	A	B	C	D
40.11	sensitive DC	<b>2</b> - 4	<b>0</b>	<b>0</b>	<b>0</b>
40.11	sensitive DC	<b>2</b> - 4	0	16	/
40.41	sensitive DC	0 - <b>2</b>	<b>0</b> - 3	<b>0</b>	<b>0</b>
40.31/51	AC-sens. DC	<b>0</b> - 2 - 5	<b>0</b> - 3	<b>0</b>	<b>0</b> - 1
40.31/51	DC	<b>0</b> - 2 - 5	<b>0</b> - 3	<b>0</b>	<b>0</b> - 1 - 3
40.52	AC-sens. DC	<b>0</b> - 2 - 5	<b>0</b> - 3	<b>0</b>	<b>0</b> - 1
40.52	DC	<b>0</b> - 2 - 5	<b>0</b> - 3	<b>0</b>	<b>0</b> - 1 - 3
40.61	AC-sens. DC	<b>0</b> - 4	<b>0</b> - 3	<b>0</b>	<b>0</b> - 1
40.61	DC	<b>0</b> - 4	<b>0</b> - 3	<b>0</b>	<b>0</b> - 1 - 3
40.31/51/ 52/61	bistable	<b>0</b>	<b>0</b>	<b>0</b>	<b>0</b>

## Technical data

Insulation according to EN 61810-1:2004					
		1 pole		2 pole	
Nominal voltage of supply system	V AC	230/400		230/400	
Rated insulation voltage	V AC	250	400	250	400
Pollution degree		3	2	3	2
<b>Insulation between coil and contact set</b>					
Type of insulation		Reinforced (8 mm)		Reinforced (8 mm)	
Overvoltage category		III		III	
Rated impulse voltage	kV (1.2/50 µs)	6		6	
Dielectric strength	V AC	4,000		4,000	
<b>Insulation between adjacent contacts</b>					
Type of insulation		—		Basic	
Overvoltage category		—		II	
Rated impulse voltage	kV (1.2/50 µs)	—		2.5	
Dielectric strength	V AC	—		2,000	
<b>Insulation between open contacts</b>					
Type of disconnection		Micro-disconnection		Micro-disconnection	
Dielectric strength	V AC/kV (1.2/50 µs)	1,000/1.5		1,000/1.5	
<b>Conducted disturbance immunity</b>					
Burst (5...50)ns, 5 kHz, on A1 - A2		EN 61000-4-4		level 4 (4 kV)	
Surge (1.2/50 µs) on A1 - A2 (differential mode)		EN 61000-4-5		level 3 (2 kV)	
<b>Other data</b>					
Bounce time: NO/NC	ms	2/5			
Vibration resistance (5...55)Hz: NO/NC	g	10/4 (1 changeover)		15/3 (2 changeover)	
Shock resistance	g	13			
Power lost to the environment	without contact current	W	0.6		
	with rated current	W	1.2 (40.11/31/41/51)		2 (40.61/52/40.11-2016)
Recommended distance between relays mounted on PCB	mm	≥ 5			

## Contact specification

**F 40 - Electrical life (AC) v contact current**  
Types 40.31/51/61

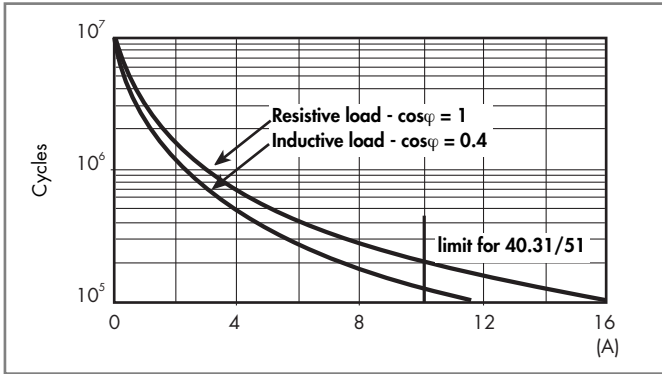

**F 40 - Electrical life (AC) v contact current**  
Type 40.52

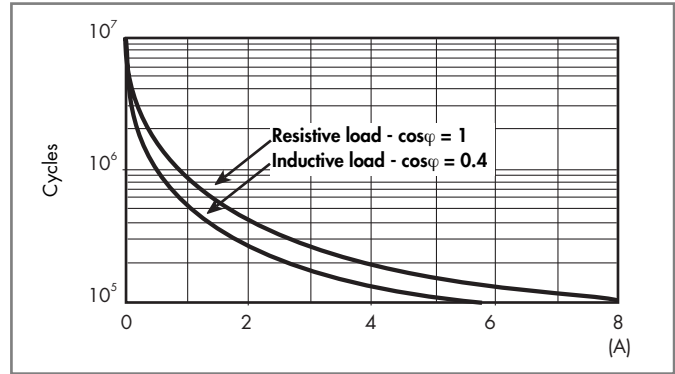

**F 40 - Electrical life (AC) v contact current**  
Types 40.11/41

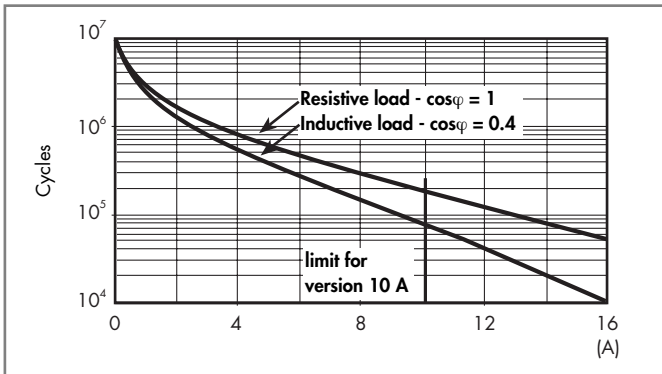

**H 40 - Maximum DC1 breaking capacity**

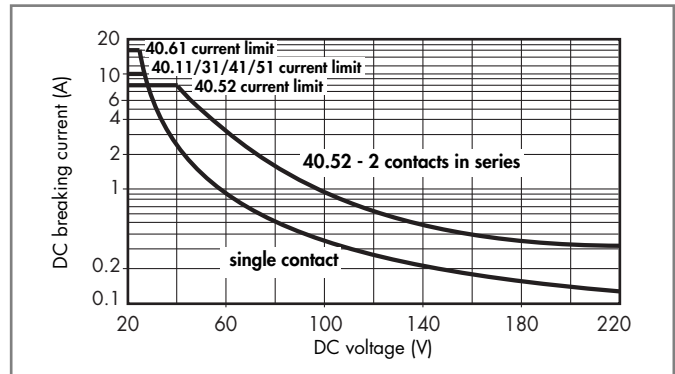

- When switching a resistive load (DC1) having voltage and current values under the curve, an electrical life of  $\geq 100 \cdot 10^3$  can be expected.
- In the case of DC13 loads, the connection of a diode in parallel with the load will permit a similar electrical life as for a DC1 load.  
Note: the release time for the load will be increased.

## Coil specifications

**DC coil data - 0.65 W standard** (types 40.31/51/52/61)

Nominal voltage $U_N$	Coil code	Operating range		Resistance R	Rated coil consumption I at $U_N$
		$U_{min}$	$U_{max}$		
V		V	V	$\Omega$	mA
5	9.005	3.65	7.5	38	130
6	9.006	4.4	9	55	109
7	9.007	5.1	10.5	75	94
9	9.009	6.6	13.5	125	72
12	9.012	8.8	18	220	55
14	9.014	10.2	21	300	47
18	9.018	13.1	27	500	36
21	9.021	15.3	31.5	700	30
24	9.024	17.5	36	900	27
28	9.028	20.5	42	1,200	23
36	9.036	26.3	54	2,000	18
48	9.048	35	72	3,500	14
60	9.060	43.8	90	5,500	11
90	9.090	65.7	135	12,500	7.2
110	9.110	80.3	165	18,000	6.2
125	9.125	91.2	187.5	23,500	5.3

**DC coil data - 0.5 W sensitive** (types 40.31/51/52/61)

Nominal voltage $U_N$	Coil code	Operating range		Resistance R	Rated coil consumption I at $U_N$
		$U_{min}^*$	$U_{max}^{**}$		
V		V	V	$\Omega$	mA
5	7.005	3.7	8.8	50	100
6	7.006	4.4	10.5	75	80
7	7.007	5.1	12.2	100	70
9	7.009	6.6	15.8	160	56
12	7.012	8.8	21	300	40
14	7.014	10.2	24.5	400	35
18	7.018	13.2	31.5	650	27.7
21	7.021	15.4	36.9	900	23.4
24	7.024	17.5	42	1,200	20
28	7.028	20.5	49	1,600	17.5
36	7.036	26.3	63	2,600	13.8
48	7.048	35	84	4,800	10
60	7.060	43.8	105	7,200	8.4
90	7.090	65.7	157	16,200	5.6
110	7.110	80.3	192	23,500	4.7
125	7.125	91.2	218.7	32,000	3.9

\* $U_{min} = 0.8 U_N$  for 40.61

\*\* $U_{max} = 1.5 U_N$  for 40.61

**DC coil data - 0.5 W sensitive** (types 40.11/41)

Nominal voltage $U_N$	Coil code	Operating range		Resistance R	Rated coil consumption I at $U_N$
		$U_{min}$	$U_{max}^*$		
V		V	V	$\Omega$	mA
6	7.006	4.4	10.5	75	80
12	7.012	8.8	21	300	40
24	7.024	17.5	42	1,200	20
48	7.048	35	84	4,600	10.4
60	7.060	43.8	105	7,200	8.3

\* $U_{max} = 1.5 U_N$  for 40.11-2016

**AC coil data** (types 40.31/51/52/61)

Nominal voltage $U_N$	Coil code	Operating range		Resistance R	Rated coil consumption I at $U_N$ (50Hz)
		$U_{min}$	$U_{max}$		
V		V	V	$\Omega$	mA
6	8.006	4.8	6.6	21	168
12	8.012	9.6	13.2	80	90
24	8.024	19.2	26.4	320	45
48	8.048	38.4	52.8	1,350	21
60	8.060	48	66	2,100	16.8
110	8.110	88	121	6,900	9.4
120	8.120	96	132	9,000	8.4
230	8.230	184	253	28,000	5
240	8.240	192	264	31,500	4.1

**AC/DC coil data - bistable** (types 40.31/51/52/61)

Nominal voltage $U_N$	Coil code	Operating range		Resistance R	Rated coil consumption I at $U_N$	DC: Release resistance** $R_{DC}$
		$U_{min}$	$U_{max}$			
V		V	V	$\Omega$	mA	$\Omega$
5	6.005	4	5.5	23	215	37
6	6.006	4.8	6.6	33	165	62
12	6.012	9.6	13.2	130	83	220
24	6.024	19.2	26.4	520	40	910
48	6.048	38.4	52.8	2,100	21	3,600
110	6.110	88	121	11,000	10	16,500

\*\*  $R_{DC}$  = Resistance in DC,  $R_{AC} = 1.3 \times R_{DC}$  1W

## Coil specifications

**R 40 - DC coil operating range v ambient temperature**  
Standard coil

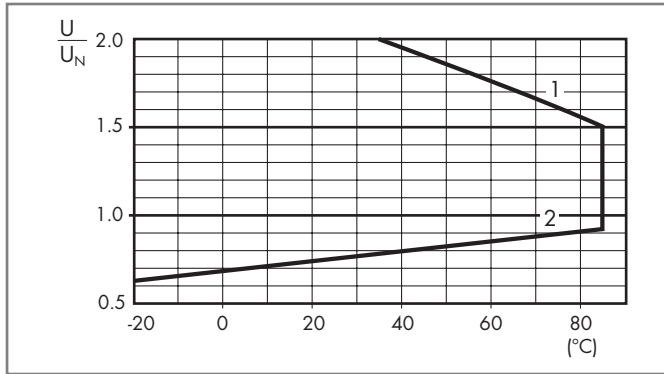

**R 40 - DC coil operating range v ambient temperature**  
Sensitive coil, types 40.31/51/52/61

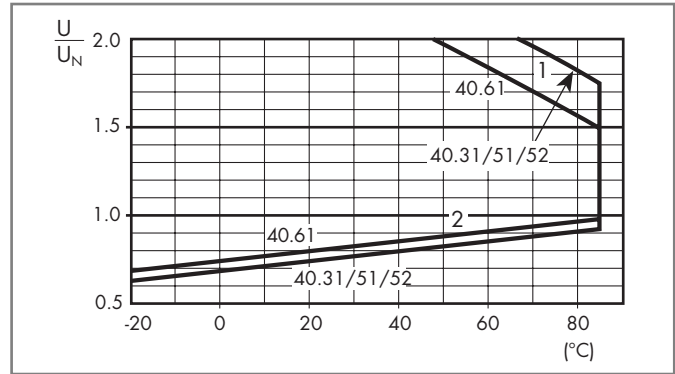

**R 40 - DC coil operating range v ambient temperature**  
Sensitive coil, types 40.11/41

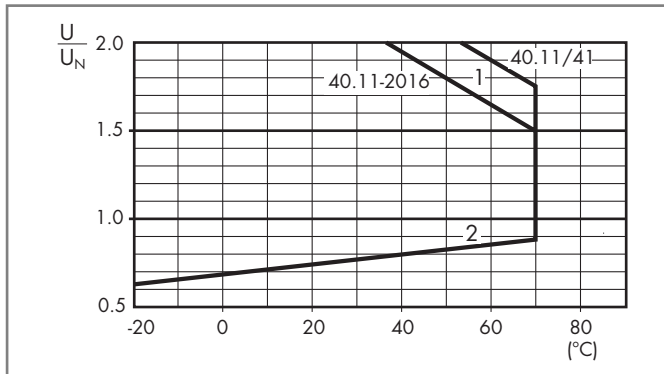

**R 40 - AC coil operating range v ambient temperature**

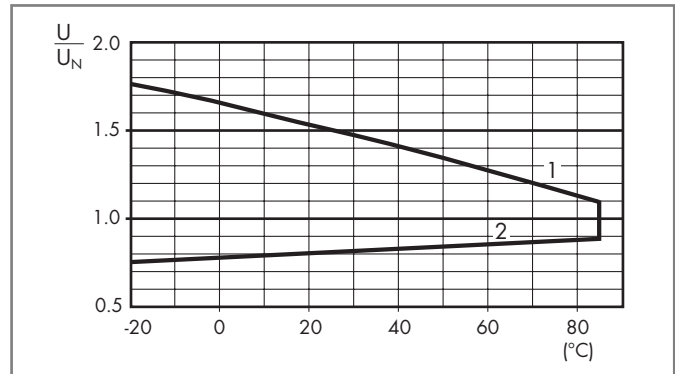

**1** - Max. permitted coil voltage.  
**2** - Min. pick-up voltage with coil at ambient temperature.

**1** - Max. permitted coil voltage.  
**2** - Min. pick-up voltage with coil at ambient temperature.

### Wiring diagram for 40 series bistable coil version

#### AC Operation

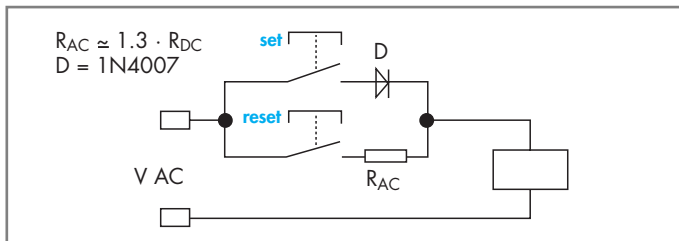

#### DC Operation

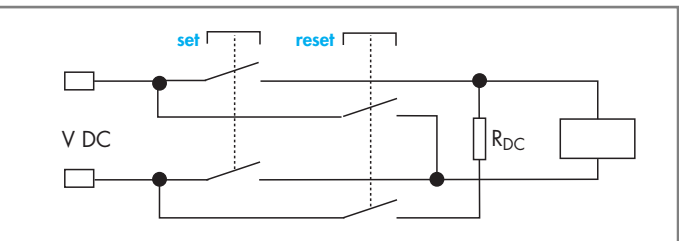

On momentary closure of the SET switch the relay is magnetised through the diode and the relay contacts transfer to the set position and remain in this position.

On momentary closure of the RESET switch the relay is demagnetised through limiting resistor ( $R_{AC}$ ) and the contacts return to the reset position.

On momentary closure of the SET switch the relay is magnetised and the relay contacts transfer to the set position and remain in this position.

On momentary closure of the RESET switch the relay is demagnetised through limiting resistor ( $R_{DC}$ ) and the contacts return to the reset position.

**Notes:** The minimum SET or RESET impulse time is 20 ms. The maximum time can be continuous. In practice, always ensure that the SET and RESET contacts cannot be operated simultaneously.





Module	Socket	Relay	Description	Mounting	Accessories
99.02	95.03	40.31	<b>Screw terminal (Box clamp) socket</b> - Top terminals - Contacts - Bottom terminals - Coil	Panel or 35 mm rail (EN 50022) mount	- Coil indication and EMC suppression modules - Jumper link - Timer modules - Plastic retaining and release clip
	95.05	40.51			
		40.52			
		40.61			

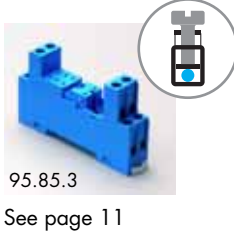

Module	Socket	Relay	Description	Mounting	Accessories
99.80	95.83.3	40.31	<b>Screw terminal (Box clamp) socket</b> 95.83.3 wiring: - Top terminals - Contacts - Bottom terminals - Coil	Panel or 35 mm rail (EN 50022) mount	- Coil indication and EMC suppression modules - Jumper link - Plastic retaining and release clip
	95.85.3	40.51			
		40.52			
		40.61			

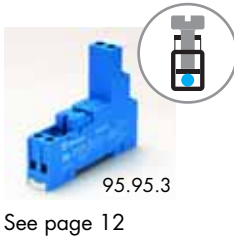

Module	Socket	Relay	Description	Mounting	Accessories
99.80	95.93.3	40.31	<b>Screw terminal (Box clamp) socket</b> - Top terminals - Contacts - Bottom terminals - Coil	Panel or 35 mm rail (EN 50022) mount	- Coil indication and EMC suppression modules - Jumper link - Plastic retaining and release clip
	95.95.3	40.51			
		40.52			
		40.61			

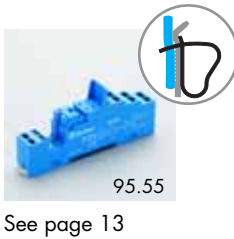

Module	Socket	Relay	Description	Mounting	Accessories
99.02	95.55	40.51	<b>Screwless terminal socket</b> - For fast cable connections - Top terminals - Contacts - Bottom terminals - Coil	Panel or 35 mm rail (EN 50022) mount	- Coil indication and EMC suppression modules - Timer modules - Plastic retaining and release clip
		40.52			
		40.61			

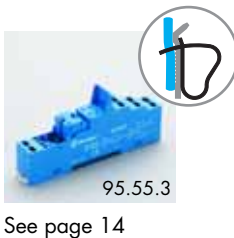

Module	Socket	Relay	Description	Mounting	Accessories
99.80	95.55.3	40.51	<b>Screwless terminal socket</b> For fast cable connections - Top terminals - Contacts - Bottom terminals - Coil	Panel or 35 mm rail (EN 50022) mount	- Coil indication and EMC suppression modules - Plastic retaining and release clip
		40.52			
		40.61			



Module	Socket	Relay	Description	Mounting	Accessories
—	95.13.2	40.31	<b>PCB socket</b>	PCB mounting	- Metal retaining clip - Plastic retaining clip
		40.41			
—	95.15.2	40.51			
		40.52			
		40.61			

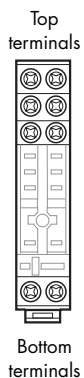



95.05

Approvals (according to type):



UL US Certain relay/socket combinations



095.01



060.72

<b>Screw terminal (Box clamp) socket panel or 35 mm rail mount</b>	<b>95.03 (blue)</b>	<b>95.03.0 (black)</b>	<b>95.05 (blue)</b>	<b>95.05.0 (black)</b>
For relay type	40.31		40.51, 40.52, 40.61	
<b>Accessories</b>				
Metal retaining clip	095.71			
Plastic retaining and release clip (supplied with socket - packaging code SPA)	095.01	095.01.0	095.01	095.01.0
8-way jumper link	095.18	095.18.0	095.18	095.18.0
Identification tag	095.00.4			
Modules (see table below)	99.02			
Timer modules (see table below)	86.30			
Sheet of marker tags for retaining and release clip 095.01 plastic, 72 tags, 6x12 mm	060.72			
<b>Technical data</b>				
Rated values	10 A - 250 V *			
Dielectric strength	6 kV (1.2/50 µs) between coil and contacts			
Protection category	IP 20			
Ambient temperature	°C -40...+70			
⊕ Screw torque	Nm 0.5			
Wire strip length	mm 8			
Max. wire size for 95.03 and 95.05 sockets	solid wire		stranded wire	
	mm <sup>2</sup>	1x6 / 2x2.5	1x4 / 2x2.5	
	AWG	1x10 / 2x14	1x12 / 2x14	

\* For currents >10 A, contact terminals must be connected in parallel (21 with 11, 24 with 14, 22 with 12). With the relay 40.51 the change-over contact will be 21-12-14.

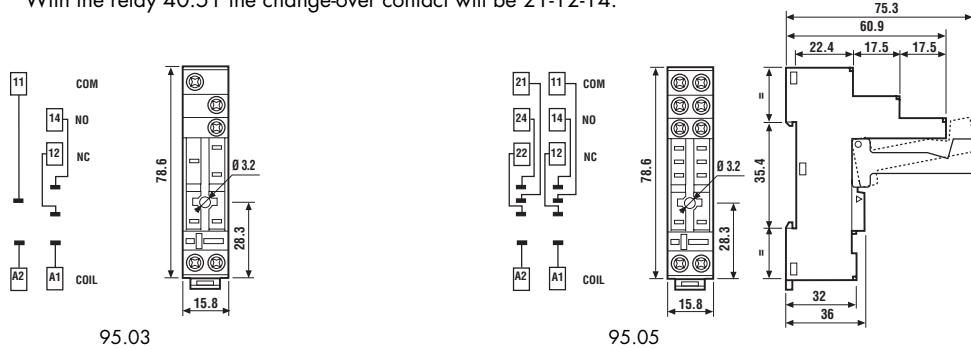

95.03

95.05

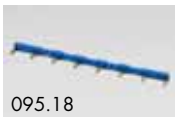

095.18

<b>8-way jumper link for 95.03 and 95.05 sockets</b>	<b>095.18 (blue)</b>	<b>095.18.0 (black)</b>
Rated values	10 A - 250 V	



86.30

<b>86 series timer modules</b>		
(12...24)V AC/DC; Bi-function: AI, DI; (0.05s...100h)	86.30.0.024.0000	
(230...240)V AC; Bi-function: AI, DI; (0.05s...100h)	86.30.8.240.0000	

Approvals (according to type): CE PG cRU US



99.02

Approvals (according to type):



<b>99.02 coil indication and EMC suppression modules for 95.03 and 95.05 sockets</b>		
Diode (+A1, standard polarity)	(6...220)V DC	99.02.3.000.00
LED	(6...24)V DC/AC	99.02.0.024.59
LED	(28...60)V DC/AC	99.02.0.060.59
LED	(110...240)V DC/AC	99.02.0.230.59
LED + Diode (+A1, standard polarity)	(6...24)V DC	99.02.9.024.99
LED + Diode (+A1, standard polarity)	(28...60)V DC	99.02.9.060.99
LED + Diode (+A1, standard polarity)	(110...220)V DC	99.02.9.220.99
LED + Varistor	(6...24)V DC/AC	99.02.0.024.98
LED + Varistor	(28...60)V DC/AC	99.02.0.060.98
LED + Varistor	(110...240)V DC/AC	99.02.0.230.98
RC circuit	(6...24)V DC/AC	99.02.0.024.09
RC circuit	(28...60)V DC/AC	99.02.0.060.09
RC circuit	(110...240)V DC/AC	99.02.0.230.09
Residual current by-pass	(110...240)V AC	99.02.8.230.07

DC Modules with non-standard polarity (+A2) on request.



95.85.3

Approvals  
(according to type):



095.91.3



060.72

<b>Screw terminal (Box clamp) socket panel or 35 mm rail mount</b>	<b>95.83.3 (blue)</b>	<b>95.83.30 (black)</b>	<b>95.85.3 (blue)</b>	<b>95.85.30 (black)</b>
For relay type	40.31		40.51, 40.52, 40.61	
<b>Accessories</b>				
Metal retaining clip	095.71			
Plastic retaining and release clip (supplied with socket - packaging code SPA)	095.91.3	095.91.30	095.91.3	095.91.30
8-way jumper link	095.08	095.08.0	095.08	095.08.0
Identification tag	095.80.3			
Modules (see table below)	99.80			
Sheet of marker tags for retaining and release clip 095.91.3 plastic, 72 tags, 6x12 mm	060.72			
<b>Technical data</b>				
Rated values	10 A - 250 V *			
Dielectric strength	6 kV (1.2/50 μs) between coil and contacts (95.83.3 only)			
Protection category	IP 20			
Ambient temperature	°C -40...+70			
⊕ Screw torque	Nm 0.5			
Wire strip length	mm 7			
Max. wire size for 95.83.3 and 95.85.3 sockets	solid wire		stranded wire	
	m <sup>2</sup>	1x6 / 2x2.5	1x4 / 2x2.5	
	AWG	1x10 / 2x14	1x12 / 2x14	

\* For currents > 10 A, contact terminals must be connected in parallel (21 with 11, 24 with 14, 22 with 12).  
With the relay 40.51 the change-over contact will be 21-12-14.

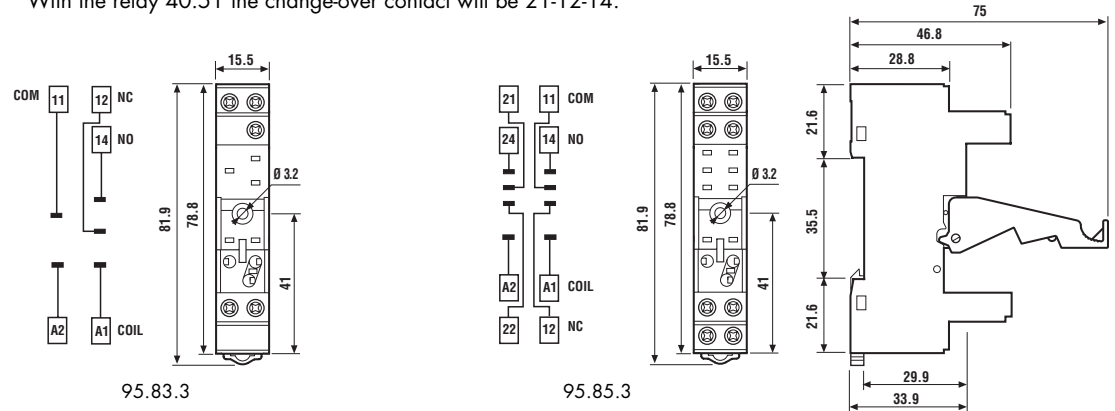

095.08

<b>8-way jumper link for 95.83.3 and 95.85.3 sockets</b>	<b>095.08 (blue)</b>	<b>095.08.0 (black)</b>
Rated values	10 A - 250 V	

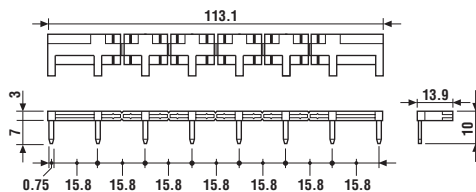

99.80

Approvals  
(according to type):



\* Modules in Black housing are available on request.

Green LED is standard.  
Red LED available on request.

<b>99.80 coil indication and EMC suppression modules for 95.83.3 and 95.85.3 sockets</b>		<b>Blue*</b>
Diode (+A1, standard polarity)	(6...220)V DC	99.80.3.000.00
LED	(6...24)V DC/AC	99.80.0.024.59
LED	(28...60)V DC/AC	99.80.0.060.59
LED	(110...240)V DC/AC	99.80.0.230.59
LED + Diode (+A1, standard polarity)	(6...24)V DC	99.80.9.024.99
LED + Diode (+A1, standard polarity)	(28...60)V DC	99.80.9.060.99
LED + Diode (+A1, standard polarity)	(110...220)V DC	99.80.9.220.99
LED + Varistor	(6...24)V DC/AC	99.80.0.024.98
LED + Varistor	(28...60)V DC/AC	99.80.0.060.98
LED + Varistor	(110...240)V DC/AC	99.80.0.230.98
RC circuit	(6...24)V DC/AC	99.80.0.024.09
RC circuit	(28...60)V DC/AC	99.80.0.060.09
RC circuit	(110...240)V DC/AC	99.80.0.230.09
Residual current by-pass	(110...240)V AC	99.80.8.230.07



Approvals  
(according to type):



<b>Screw (Box clamp) terminal socket panel or 35 mm rail mount</b>	<b>95.93.3 (blue)</b>	<b>95.93.30 (black)</b>	<b>95.95.3 (blue)</b>	<b>95.95.30 (black)</b>
For relay type	40.31		40.51, 40.52, 40.61	
<b>Accessories</b>				
Metal retaining clip	095.71			
Plastic retaining and release clip	095.91.3	095.91.30	095.91.3	095.91.30
8-way jumper link	095.08	095.08.0	095.08	095.08.0
Identification tag	095.80.3			
Modules (see table below)	99.80			
Sheet of marker tags for retaining and release clip 095.91.3 plastic, 72 tags, 6x12 mm	060.72			
<b>Technical data</b>				
Rated values	10 A - 250 V *			
Dielectric strength	6 kV (1.2/50 µs) between coil and contacts			
Protection category	IP 20			
Ambient temperature	°C -40...+70			
⊕ Screw torque	Nm	0.5		
Wire strip length	mm	8		
Max. wire size for 95.93.3 and 95.95.3 sockets		solid wire	stranded wire	
	m <sup>2</sup>	1x6 / 2x2.5	1x4 / 2x2.5	
	AWG	1x10 / 2x14	1x12 / 2x14	

\* For currents >10 A, contact terminals must be connected in parallel (21 with 11, 24 with 14, 22 with 12).  
With the relay 40.51 the change-over contact will be 21-12-14.

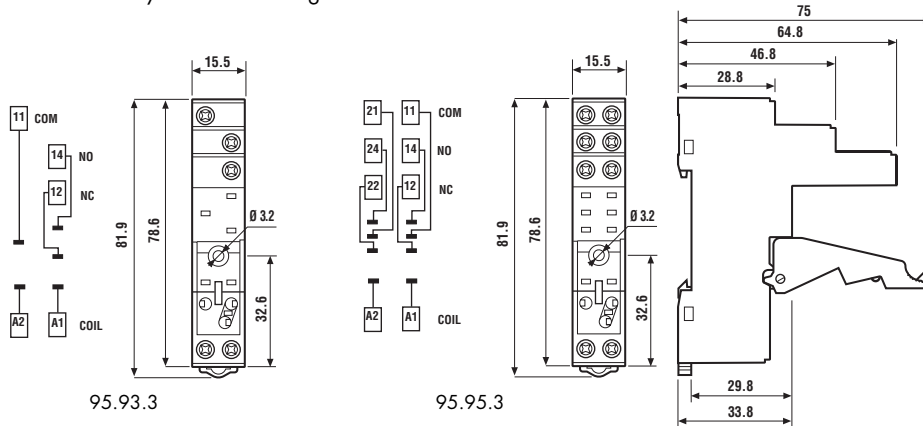

<b>8-way jumper link for 95.93.3 and 95.95.3 sockets</b>	<b>095.08 (blue)</b>	<b>095.08.0 (black)</b>
Rated values	10 A - 250 V	

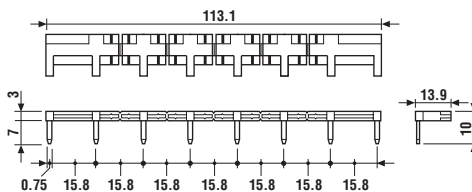

Approvals  
(according to type):



\* Modules in Black housing are available on request.

Green LED is standard.  
Red LED available on request.

<b>99.80 coil indication and EMC suppression modules for 95.93.3 and 95.95.3 sockets</b>		<b>Blue*</b>
Diode (+A1, standard polarity)	(6...220)V DC	99.80.3.000.00
LED	(6...24)V DC/AC	99.80.0.024.59
LED	(28...60)V DC/AC	99.80.0.060.59
LED	(110...240)V DC/AC	99.80.0.230.59
LED + Diode (+A1, standard polarity)	(6...24)V DC	99.80.9.024.99
LED + Diode (+A1, standard polarity)	(28...60)V DC	99.80.9.060.99
LED + Diode (+A1, standard polarity)	(110...220)V DC	99.80.9.220.99
LED + Varistor	(6...24)V DC/AC	99.80.0.024.98
LED + Varistor	(28...60)V DC/AC	99.80.0.060.98
LED + Varistor	(110...240)V DC/AC	99.80.0.230.98
RC circuit	(6...24)V DC/AC	99.80.0.024.09
RC circuit	(28...60)V DC/AC	99.80.0.060.09
RC circuit	(110...240)V DC/AC	99.80.0.230.09
Residual current by-pass	(110...240)V AC	99.80.8.230.07

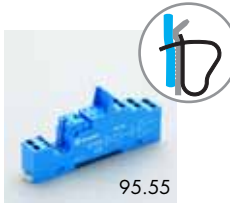

Approvals  
(according to type):



<b>Screwless terminal socket panel or 35 mm rail mount</b>	<b>95.55 (blue)</b>	<b>95.55.0 (black)</b>
For relay type	40.51, 40.52, 40.61	
<b>Accessories</b>		
Metal retaining clip	095.71	
Plastic retaining and release clip (supplied with socket - packaging code SPA)	095.91.3	
Modules (see table below)	99.02	
Timer modules (see table below)	86.30	
Sheet of marker tags for retaining and release clip 095.91.3 plastic, 72 tags, 6x12 mm	060.72	
<b>Technical data</b>		
Rated values	10 A - 250 V *	
Dielectric strength	6 kV (1.2/50 μs) between coil and contacts	
Protection category	IP 20	
Ambient temperature	°C -25...+70	
Wire strip length	mm 8	
Max. wire size for 95.55 socket	solid wire	stranded wire
	mm <sup>2</sup> 2x(0.2...1.5)	2x(0.2...1.5)
	AWG 2x(24...18)	2x(24...18)

\* For currents >10 A, contact terminals must be connected in parallel (21 with 11, 24 with 14, 22 with 12).  
With the relay 40.51 the change-over contact will be 21-12-14.

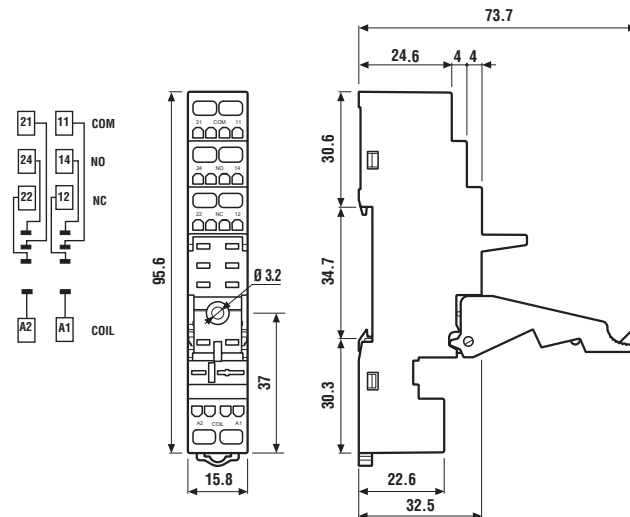

<b>86 series timer modules</b>		
(12...24)V AC/DC; Bi-function: AI, DI; (0.05s...100h)	86.30.0.024.0000	
(230...240)V AC; Bi-function: AI, DI; (0.05s...100h)	86.30.8.240.0000	

Approvals  
(according to type):



Approvals  
(according to type):



<b>99.02 coil indication and EMC suppression modules for 95.55 socket</b>		
Diode (+A1, standard polarity)	(6...220)V DC	99.02.3.000.00
LED	(6...24)V DC/AC	99.02.0.024.59
LED	(28...60)V DC/AC	99.02.0.060.59
LED	(110...240)V DC/AC	99.02.0.230.59
LED + Diode (+A1, standard polarity)	(6...24)V DC	99.02.9.024.99
LED + Diode (+A1, standard polarity)	(28...60)V DC	99.02.9.060.99
LED + Diode (+A1, standard polarity)	(110...220)V DC	99.02.9.220.99
LED + Varistor	(6...24)V DC/AC	99.02.0.024.98
LED + Varistor	(28...60)V DC/AC	99.02.0.060.98
LED + Varistor	(110...240)V DC/AC	99.02.0.230.98
RC circuit	(6...24)V DC/AC	99.02.0.024.09
RC circuit	(28...60)V DC/AC	99.02.0.060.09
RC circuit	(110...240)V DC/AC	99.02.0.230.09
Residual current by-pass	(110...240)V AC	99.02.8.230.07

DC Modules with  
non-standard polarity  
(+A2) on request.

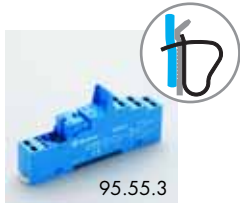

Approvals  
(according to type):



<b>Screwless terminal socket panel or 35 mm rail mount</b>	<b>95.55.3 (blue)</b>	<b>95.55.30 (black)</b>	
For relay type	40.51, 40.52, 40.61		
<b>Accessories</b>			
Metal retaining clip	095.71		
Plastic retaining and release clip (supplied with socket - packaging code SPA)	095.91.3		
Modules (see table below)	99.80		
Sheet of marker tags for retaining and release clip 095.91.3 plastic, 72 tags, 6x12 mm	060.72		
<b>Technical data</b>			
Rated values	10 A - 250 V *		
Dielectric strength	6 kV (1.2/50 μs) between coil and contacts		
Protection category	IP 20		
Ambient temperature °C	-25...+70		
Wire strip length mm	8		
Max. wire size for 95.55.3 socket	solid wire	stranded wire	
	mm <sup>2</sup>	2x(0.2...1.5)	2x(0.2...1.5)
	AWG	2x(24...18)	2x(24...18)

\* For currents >10 A, contact terminals must be connected in parallel (21 with 11, 24 with 14, 22 with 12).  
With the relay 40.51 the change-over contact will be 21-12-14.

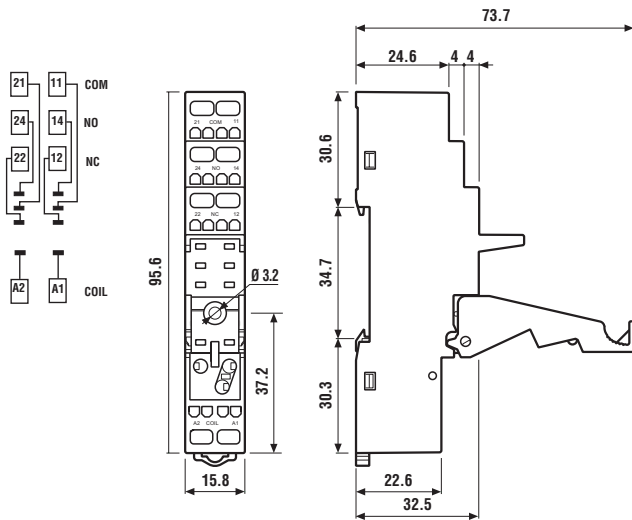

Approvals  
(according to type):



\* Modules in Black housing are available on request.

Green LED is standard.  
Red LED available on request.

<b>99.80 coil indication and EMC suppression modules for 95.55.3 socket</b>		<b>Blue*</b>
Diode (+A1, standard polarity)	(6...220)V DC	99.80.3.000.00
LED	(6...24)V DC/AC	99.80.0.024.59
LED	(28...60)V DC/AC	99.80.0.060.59
LED	(110...240)V DC/AC	99.80.0.230.59
LED + Diode (+A1, standard polarity)	(6...24)V DC	99.80.9.024.99
LED + Diode (+A1, standard polarity)	(28...60)V DC	99.80.9.060.99
LED + Diode (+A1, standard polarity)	(110...220)V DC	99.80.9.220.99
LED + Varistor	(6...24)V DC/AC	99.80.0.024.98
LED + Varistor	(28...60)V DC/AC	99.80.0.060.98
LED + Varistor	(110...240)V DC/AC	99.80.0.230.98
RC circuit	(6...24)V DC/AC	99.80.0.024.09
RC circuit	(28...60)V DC/AC	99.80.0.060.09
RC circuit	(110...240)V DC/AC	99.80.0.230.09
Residual current by-pass	(110...240)V AC	99.80.8.230.07





Approvals  
(according to type):



PCB socket	95.13.2 (blue)	95.13.20 (black)	95.15.2 (blue)	95.15.20 (black)
For relay type	40.31, 40.41		40.51, 40.52, 40.61	
Accessories				
Metal retaining clip (supplied with socket - packaging code SMA)			095.51	
Plastic retaining clip			095.52	
Technical data				
Rated values	10 A - 250 V *			
Dielectric strength	6 kV (1.2/50 μs) between coil and contacts			
Protection category	IP 20			
Ambient temperature	°C -40...+70			

\* For currents >10 A, contact terminals must be connected in parallel (21 with 11, 24 with 14, 22 with 12).  
With the relay 40.51 the change-over contact will be 21-12-14.

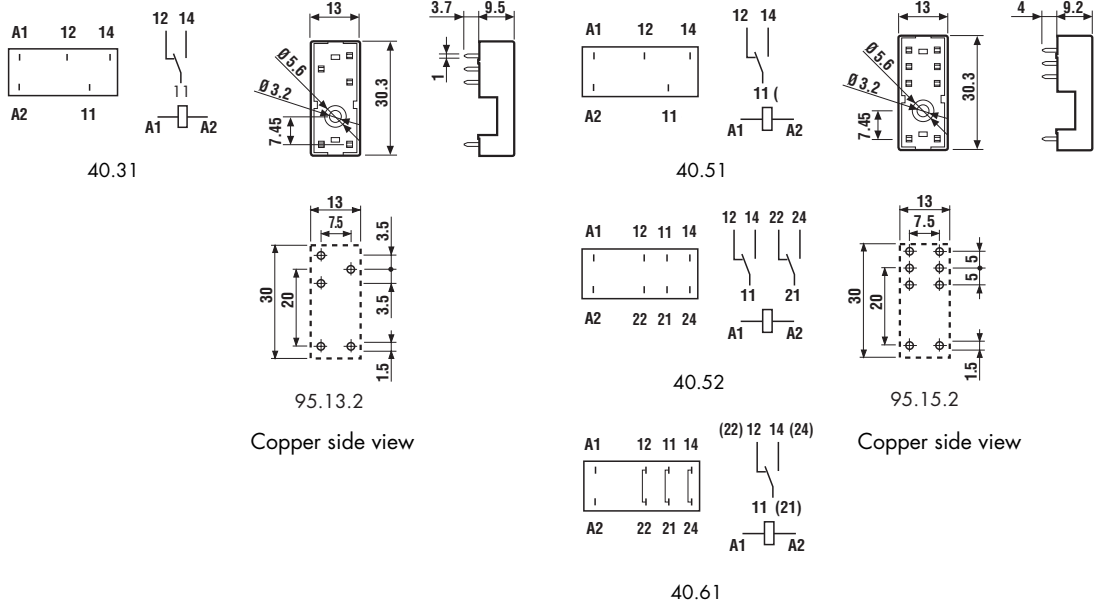

## Packaging codes

How to code and identify retaining clip and packaging options for sockets.

Example:

9 5 . 0 5 S P A

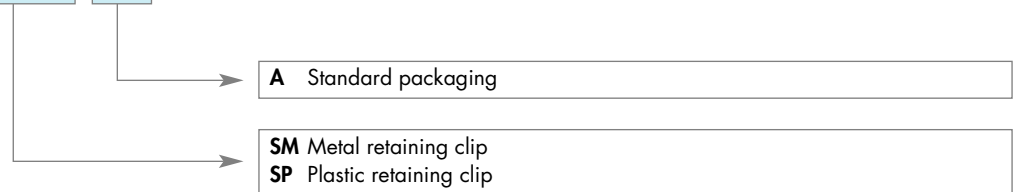

9 5 . 0 5 [ ] [ ]

Without retaining clip

