

Air Cylinder: Standard/Non-rotating Rod Double Acting/Single Acting, Single Rod/Double Rod

Series *NCM*

ø3/4", ø7/8", ø1 1/16", ø1 1/4", ø1 1/2", ø2"



CJ1

CJP

CJ2

CM2

CG1

MB

MB1

CA2

CS1

C76

C85

C95

CP95

NCM

NCA

D-

-X

20-

Data

**Double Rod/Double End Mounting
Non-rotating Rod Option
Auto Switch Capable**

Auto Switch Specifications/Option Compatibility

Applicable Auto Switch/Refer to page 6-16-1 for further information on auto switches.

Type	Special function	Electrical entry	Indicator light	Wiring (Output)	Load voltage		Auto switch model	Lead wire length (m)*				Pre-wire connector	Applicable load			
					DC	AC		0.5 (Nil)	3 (L)	5 (Z)	None (N)					
Reed switch	—	Grommet	Yes	2-wire	24 V	12 V	100 V	C73	●	●	●	—	—	—	Relay, PLC	
			No			5 V, 12 V	100 V or less	C80	●	●	—	—	—			IC circuit
			Yes			—	—	B53	●	●	●	—				
			No			12 V	100 V, 200 V 200 V or less	B54 B64	●	●	●	—	—			—
		Connector	Yes			—	—	C73C	●	●	●	●		—	—	
			No			5 V, 12 V	24 V or less	C80C	●	●	●	●	—	IC circuit		
	Diagnostic indication (2-color indication)	Grommet	Yes			—	—	B59W	●	●	—	—	—	—	—	
Solid state switch	—	Grommet	—	—	24 V	5 V, 12 V	—	H7A1	●	●	○	—	○	—	IC circuit	
								H7A2	●	●	○	—	○			
	Connector	—	—	—	—	12 V	—	H7B	●	●	○	—	○	—	—	
								H7C	●	●	●	●	—			—
	Diagnostic indication (2-color indication)	Grommet	Yes	—	—	5 V, 12 V	—	H7NW	●	●	○	—	○	—	IC circuit	
								H7PW	●	●	○	—	○			
								H7BW	●	●	○	—	○			
								H7BA	—	●	○	—	○			
	Water resistant (2-color indication)	Grommet	—	—	—	12 V	—	H7NF	●	●	○	—	○	—	—	
								G59	●	●	○	—	○			
With diagnostic output (2-color indication)	Grommet	—	—	—	5 V, 12 V	—	K59	●	●	○	—	○	—	IC circuit		
							K59	●	●	○	—	○				
—	—	—	—	—	12 V	—	—	—	—	—	—	—	—	—	—	

* Lead wire length symbols: 0.5 m Nil (Example) C73C
 3 m L (Example) C73CL
 5 m Z (Example) C73CZ
 None N (Example) C73CN

* Solid state switches marked with "○" are produced upon receipt of order.

• For details about auto switches with pre-wire connector, refer to page 6-16-60.

Option Compatibility

	Description	Note	NCM - Standard	NCDM	NCMW	NCMK	NCM-*J	NCM-*K	S	T	C	XB6	XB7	XB9	XC6
NCM	Standard		—												
NCDM	Auto switch capable		○	—											
NCMW	Double rod		○	○	—										
NCMK	Non-rotating	1	○	○	S	—									
NCM-*J	Nylon rod boot	1	○	○	S	S	—								
NCM-*K	Neoprone rod boot	1	○	○	S	S	N	—							
S	Spring return	1	○	○	S	S	S	S	—						
T	Spring extend	1	○	○	S	S	S	S	N	—					
C	Rubber bumper	2	○	○	○	S	S	O	N	O	—				
XB6	Heat resistant	1	○	S	O	N	S	S	O	N	N	—			
XB7	Cold resistant	1	○	S	O	N	S	S	O	N	N	N	—		
XB9	Low speed	1	○	○	S	N	S	S	N	N	O	N	N	—	
XC6	Stainless steel rod	3, 4	○	○	○	○	○	○	N	O	O	O	O	O	—
B	Rod side nose mounting		○	○	○	○	○	○	○	○	○	○	○	○	○
C	Head side pivot mounting	1	○	○	N	○	○	○	○	○	○	○	○	○	○
E	Double end mounting		○	○	N	○	○	○	○	○	○	○	○	○	○
R	Block mounting	1, 5, 6	○	○	S	S	N	N	O	O	O	S	S	O	O

○ Combination available to order
 S Available with special request
 N Not available

Note 1) This table is not applicable for ø200.
 Note 2) Rubber cushion no additional charge on ø088 and ø125.
 Note 3) Stainless steel rod standard on ø075 and ø088. Use XC6 option to get stainless steel rod nut.
 Note 4) Non-rotating rod is stainless steel. Use XC6 option to get stainless steel rod nut.
 Note 5) Block mount not available in ø088 and ø125.
 Note 6) Block, Auto switch capable, S and T only available as special.

CJ1

CJP

CJ2

CM2

CG1

MB

MB1

CA2

CS1

C76

C85

C95

CP95

NCM

NCA

D-

-X

20-

Data

Series NCM

Specifications: Double Acting, Single Rod/Double Rod

Specifications

Bore size (in)	075 (3/4")	088 (7/8")	106 (1 1/16")	125 (1 1/4")	150 (1 1/2")	200 (2")
Fluid	Air					
Maximum operating pressure	250 PSI/1.7 MPa					
Minimum operating pressure	8 PSI/0.06 MPa					
Ambient and fluid temperature	40 to 140°F/5 to 60 °F					
Piston speed	No bumper: 2 to 20 in/sec (50 to 500 mm/sec) Rubber bumper: 2 to 30 in/sec (50 to 750 mm/sec)					
Rubber bumper	Option (No additional charge on 7/8" and 1 1/4" bore)					
Lubrication	Not required (Pre-lubricated at Factory)					
Mounting	B, C, E, R					

Note) R mount available on ø3/4", ø1 1/16", and ø1 1/2" only.

Standard Stroke

(in)

Mounting	Standard stroke	Max. stroke as standard	Long stroke
Rod side nose (B)	1/2, 1, 2, 3, 4, 5, 6	12	40
Double end (E)	1/2, 1, 2, 3, 4, 5, 6	32	40
Head side pivot (C)	7, 8, 10, 12		
Double rod (W)	1/2, 1, 2, 3, 4, 5, 6	12	20
Block mount (R)	1/2, 1, 1 1/2, 2, 3, 4, 5, 6	12	40

Note) Minimum stroke for mounting auto switches: 0.6 inch for 2 switches, 0.4 inch for one switch.

Specifications: Double Acting, Single Rod, Non-rotating Rod

Specifications

Bore size (in)	075 (3/4")	088 (7/8")	106 (1 1/16")	125 (1 1/4")	150 (1 1/2")
Fluid	Air				
Maximum operating pressure	250 PSI/1.7 MPa				
Minimum operating pressure	8 PSI/0.06 MPa				
Ambient and fluid temperature	40 to 140°F/5 to 60 °F				
Piston speed	2 to 20 in/sec/50 to 500 mm/sec				
Rod material	Stainless steel 304 (JIS)				
Rubber bumper	Option (No additional charge on 7/8" and 1 1/4" bore)				
Non-rotating accuracy	±2.0°		± 1.4°		
Maximum allowable torque	0.04 ft·Lbf (0.06 N·m)	0.09 ft·Lbf (0.13 N·m)	0.12 ft·Lbf (0.16 N·m)		

Standard Stroke

(in)

Mounting	Standard stroke	Max. stroke as standard	Long stroke
Rod side nose (B)	1/2, 1, 2, 3, 4, 5, 6	12	40
Double end (E)	1/2, 1, 2, 3, 4, 5, 6	32	40
Head side pivot (C)	7, 8, 10, 12		

Note 1) Minimum stroke for mounting auto switches: 0.6 inch for 2 switches, 0.4 inch for one switch.

Note 2) Spring return up to 18" available as special request

Specifications: Single Acting, Spring Return, Spring Extend

Specifications

Bore size (in)	075 (3/4")	088 (7/8")	106 (1 1/16")	125 (1 1/4")	150 (1 1/2")	200 (2")
Fluid	Air					
Maximum operating pressure	250 PSI/1.7 MPa					
Minimum operating pressure	25 PSI/0.18 MPa					
Ambient and fluid temperature	40 to 140°F/5 to 60 °F					
Piston speed	2 to 20 in/sec/50 to 500 mm/s					
Rubber bumper	Option (No additional charge on 7/8" and 1 1/4" bore)					
Lubrication	Not required (Pre-lubricated at Factory)					
Mounting	B, C, E, R					

Note) R mount available on 3/4", 1 1/16", and 1 1/2" bore only.

Standard Stroke

(in)

Mounting	Standard stroke	Maximum Stroke
Rod side nose (B)	1/2, 1, 1 1/2, 2, 3, 4	6
Double end (E)		
Head side pivot (C)		
Block mount (R)		

Note) Up to 18" available as special request.

Specifications: Single Acting Spring Return, Non Rotating Rod

Specifications

Bore size (in)	075 (3/4")	088 (7/8")	106 (1 1/16")	125 (1 1/4")	150 (1 1/2")
Fluid	Air				
Maximum operating pressure	250 PSI/1.7 MPa				
Minimum operating pressure	25 PSI/0.18 MPa				
Ambient and fluid temperature	40 to 140°F/5 to 60 °F				
Piston speed	2 to 20 in/sec/50 to 500 mm/s				
Rod material	Stainless steel 304				
Rubber bumper	Option (No additional charge on 7/8" and 1 1/4" bore)				
Non-rotating accuracy	± 2.0°		± 1.4°		
Maximum allowable torque	0.04 ft·Lbf (0.06 N·m)	0.09 ft·Lbf (0.13 N·m)	0.12 ft·Lbf (0.16 N·m)		

Standard Stroke Availability

(in)

Mounting	Standard stroke	Max. stroke
Rod side nose (B)	1/2, 1, 2, 3, 4, 5, 6	6
Double end mounting (E)	1/2, 1, 2, 3, 4, 5, 6	8
Head side pivot (C)	1/2, 1, 2, 3, 4, 5, 6	

Note 1) Minimum stroke for mounting auto switches: 0.6 inch for 2 switches, 0.4 inch for one switch.

Note 2) Spring Return up to 18" available as special request.

CJ1

CJP

CJ2

CM2

CG1

MB

MB1

CA2

CS1

C76

C85

C95

CP95

NCM

NCA

D-

-X

20-

Data

Series NCM

Specifications: Rod Boot

Rod Boot Material

Symbol	Material	Maximum ambient temperature
J	Nylon tarpaulin	140°F (60°C)
K	Heat resistant tarpaulin	230°F (110°C)*

* Maximum ambient temperature is for the rod boot only.

Maximum Stroke

Bore size (in)	Maximum stroke
3/4, 7/8, 1 1/16	12 STD.—16 Max.
1 1/4, 1 1/2, 2	12 STD.—26 Max.

Parts No. of Auto Switch Mounting Band

Auto switch part number	Bore size				
	075	088	106	125	150
D-G59, D-B54, D-B64, D-K59, D-B53	NBA-075	NBA-088	NBA-106	NBA-125	NBA-150
D-C73 D-H7A1	NBM2-075	NBM2-088	NBM2-106	NBM2-125	NBM2-150

Minimum Stroke for Auto Switches Mounting (NCDM)

(in)

Auto switch model	Number of switches				
	2		n		1
	On different surfaces	On the same surfaces	On different surfaces	On the same surfaces	
D-C7 D-C8	0.6	2.3	$0.6 + 1.8\left(\frac{n-2}{2}\right)$ (n = 2, 4, 6...)	$2.3 + 1.8(n - 2)$	0.4
D-H7□ D-H7□W D-H7BAL D-H7NF	0.6	2.3			0.4
D-C73C C-C80C D-H7C	0.6	3.1	$0.6 + 2\left(\frac{n-2}{2}\right)$ (n = 2, 4, 6...)	$3.1 + 2(n - 2)$	0.4
D-H7LF	0.8	2.8	$0.8 + 2\left(\frac{n-2}{2}\right)$ (n = 2, 4, 6...)	$2.8 + 2(n - 2)$	0.4
D-B5 D-B6	0.6	2.7	$0.6 + 2\left(\frac{n-2}{2}\right)$ (n = 2, 4, 6...)	$2.7 + 2.2(n - 2)$	0.4
D-B59W	0.8	2.9	$0.8 + 2\left(\frac{n-2}{2}\right)$ (n = 2, 4, 6...)	$2.9 + 2.2(n - 2)$	0.6
D-G59 D-K59	0.6	2.8	$0.6 + 2\left(\frac{n-2}{2}\right)$ (n = 2, 4, 6...)	$2.8 + 2(n - 2)$	0.4

Construction: Double Acting, Single Rod

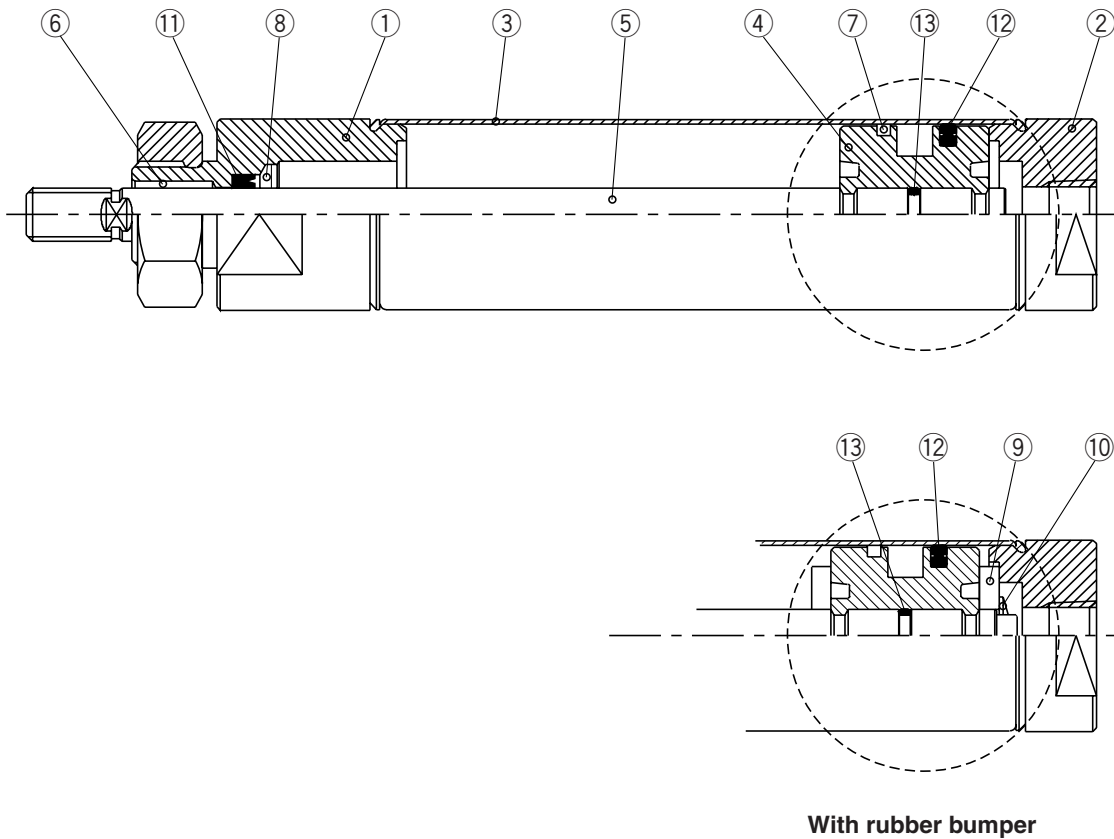

With rubber bumper

Component Parts

No.	Description	Material	Note
①	Rod cover	Aluminum alloy	Clear anodized
②	Head cover	Aluminum alloy	Clear anodized
③	Cylinder tube	Stainless steel	Stainless steel 304
④	Piston	Aluminum alloy	Chromated
⑤	Piston rod	3/4", 7/8"	Stainless steel
		1 1/16", 1 1/2", 1 1/4", 2"	Carbon steel
⑥	Bushing	Sintered BR	—
⑦	Wear ring	Phenolic resin	—
⑧	Snap ring	Spring steel	—
⑨	Rubber bumper	Urethane	—
⑩	Snap ring	Spring steel	—
⑪	Rod seal	NBR	—
⑫	Piston seal	NBR	—
⑬	Piston gasket	NBR	—

CJ1

CJP

CJ2

CM2

CG1

MB

MB1

CA2

CS1

C76

C85

C95

CP95

NCM

NCA

D-

-X

20-

Data

Series NCM

Construction: Double Acting, Double Rod

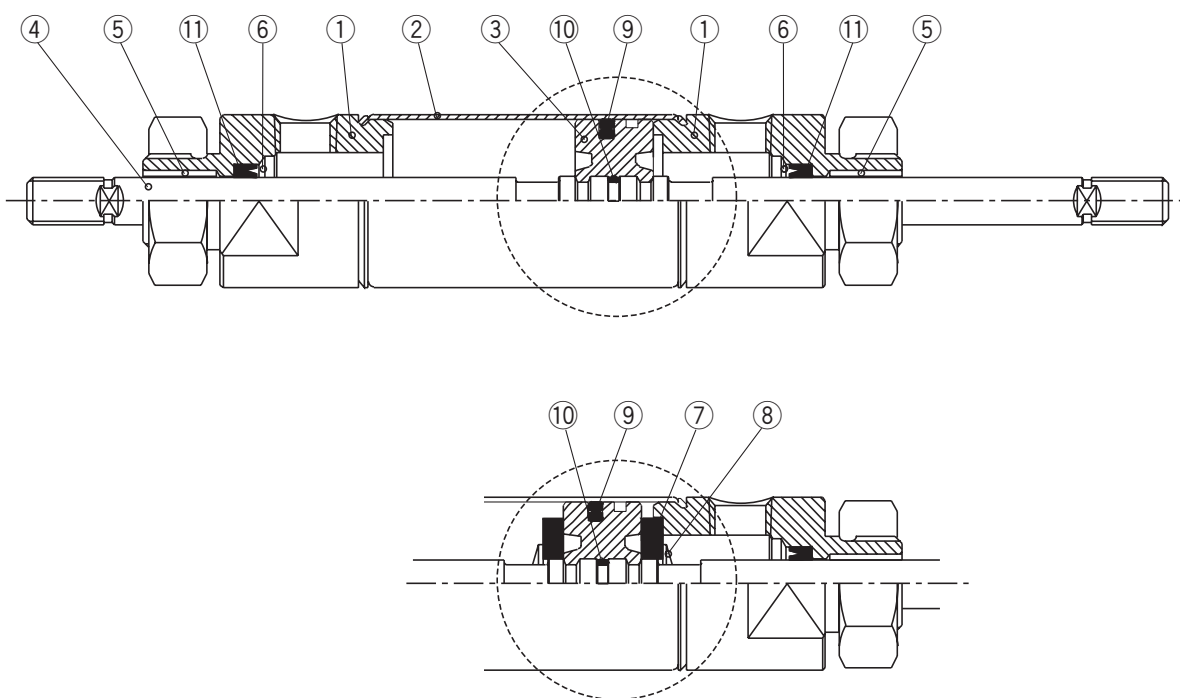

Component Parts

No.	Description	Material	Note
①	Rod cover	Aluminum alloy	Clear anodized
②	Cylinder tube	Stainless steel	Stainless steel 304
③	Piston	Aluminum alloy	Chromated
④	Piston rod	3/4", 7/8"	Stainless steel
		1 1/16", 1 1/2", 1 1/4", 2"	Carbon steel
⑤	Bushing	Sintered BR	—
⑥	Snap ring	Spring steel	—
⑦	Rubber bumper	Urethane	—
⑧	Snap ring	Spring steel	—
⑨	Piston seal	NBR	—
⑩	Piston gasket	NBR	—
⑪	Rod seal	NBR	—

Construction: Double Acting, Single Rod, Non-rotating

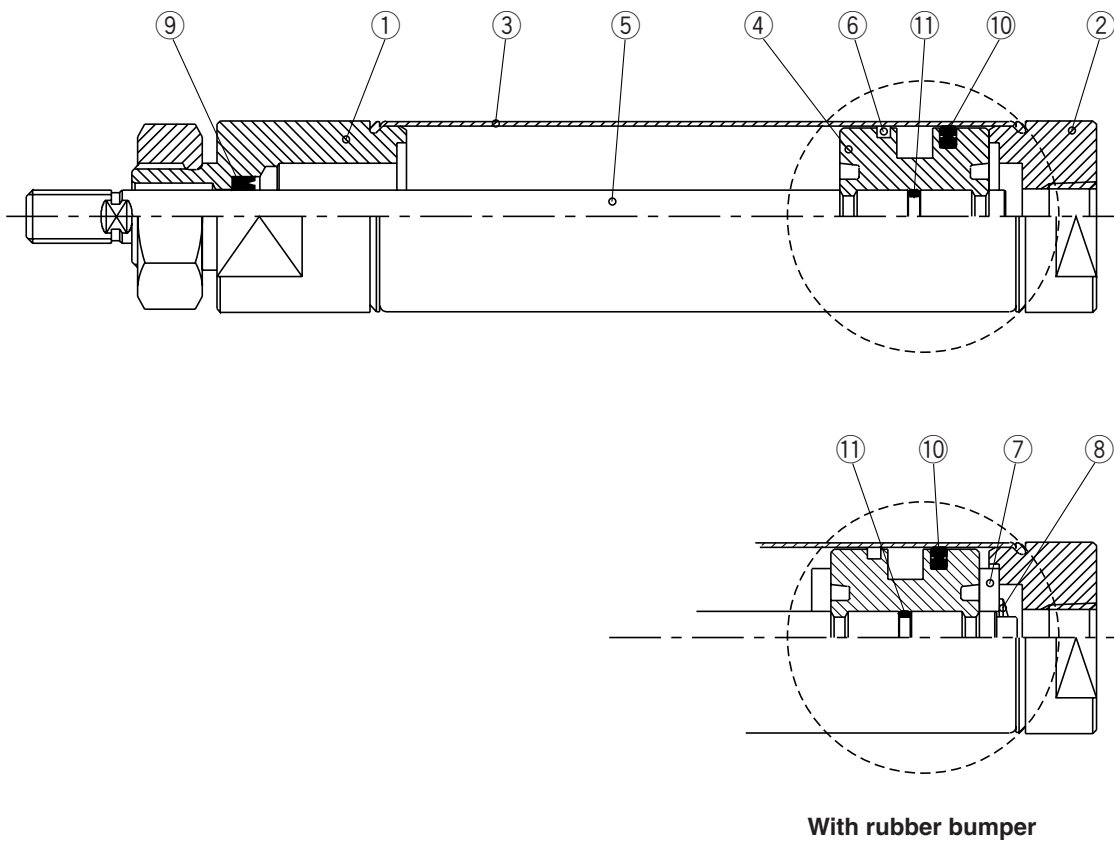

Component Parts

No.	Description	Material	Note
①	Rod cover	Aluminum alloy	Clear anodized
②	Head cover	Aluminum alloy	Clear anodized
③	Cylinder tube	Stainless steel	Stainless steel 304
④	Piston	Aluminum alloy	Chromated
⑤	Piston rod	Stainless steel	—
⑥	Wear ring	Phenolic resin	—
⑦	Rubber bumper	Urethane	—
⑧	Snap ring	Spring steel	—
⑨	Rod seal	NBR	—
⑩	Piston seal	NBR	—
⑪	Piston gasket	NBR	—

CJ1

CJP

CJ2

CM2

CG1

MB

MB1

CA2

CS1

C76

C85

C95

CP95

NCM

NCA

D-

-X

20-

Data

Series NCM

Construction: Single Acting, Spring Extend

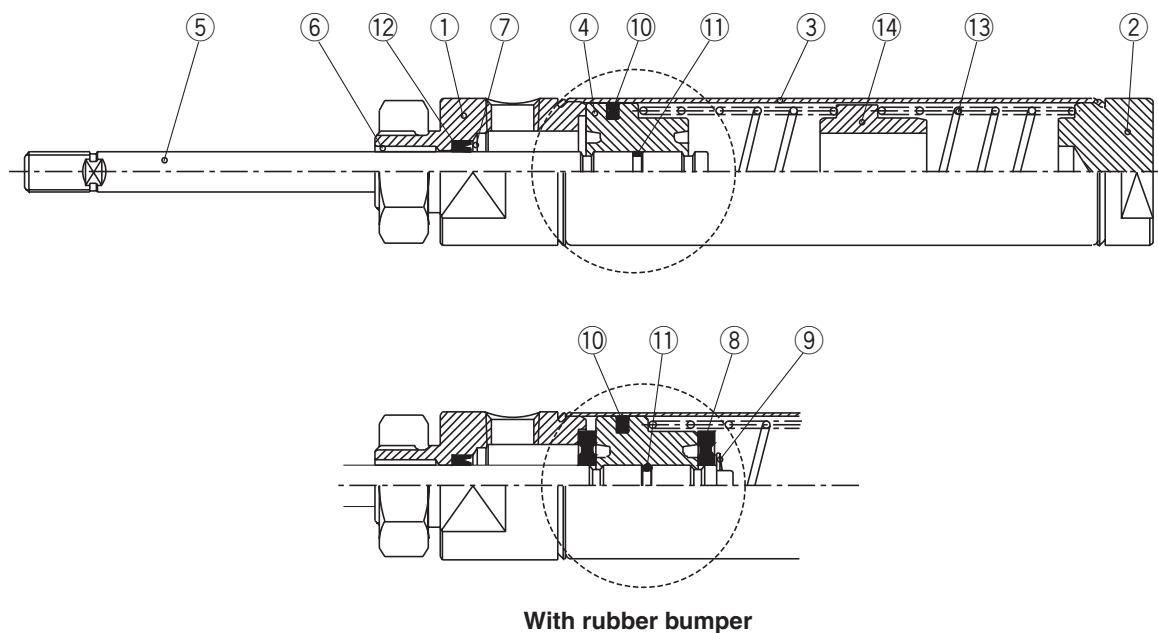

Component Parts

No.	Description	Material	Note
①	Rod cover	Aluminum alloy	Clear anodized
②	Head cover	Aluminum alloy	Clear anodized
③	Cylinder tube	Stainless steel	Stainless steel 304
④	Piston	Aluminum alloy	Chromated
⑤	Piston rod	3/4", 7/8"	Stainless steel
		1 1/16", 1 1/2", 1 1/4", 2"	Carbon steel
⑥	Bushing	Sintered BR	—
⑦	Snap ring	Spring steel	—
⑧	Rubber bumper	Urethane	—
⑨	Snap ring	Spring steel	—
⑩	Piston seal	NBR	—
⑪	Piston gasket	NBR	—
⑫	Rod seal	NBR	—
⑬	Spring	Piano wire	Chromated
⑭	Spring guide	Aluminum alloy	Chromated

Construction: Single Acting, Spring Return

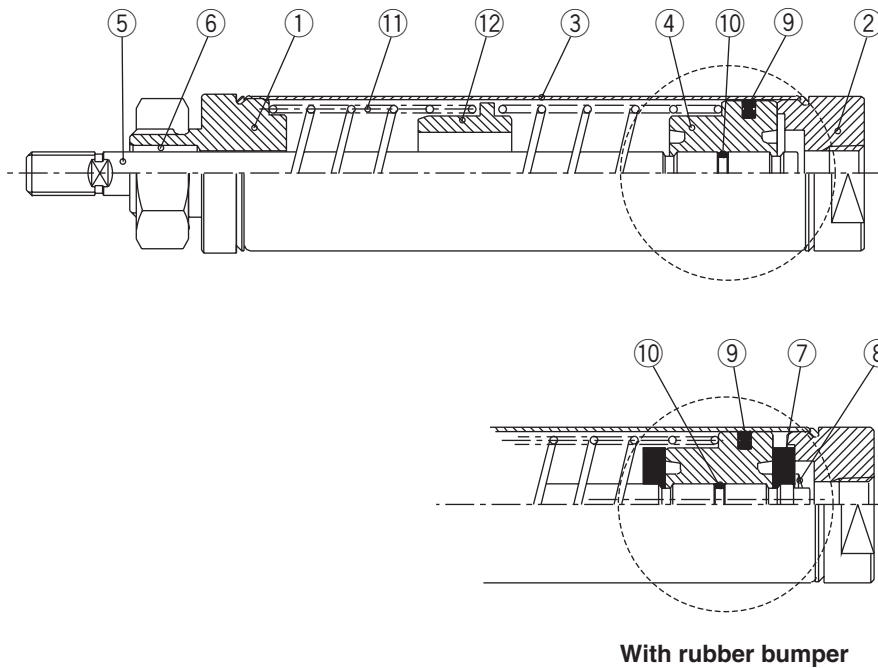

Component Parts

No.	Description	Material	Note
①	Rod cover	Aluminum alloy	Clear anodized
②	Head cover	Aluminum alloy	Clear anodized
③	Cylinder tube	Stainless steel	Stainless steel 304
④	Piston	Aluminum alloy	Chromated
⑤	Piston rod	3/4", 7/8"	Stainless steel
		1 1/16", 1 1/2", 1 1/4", 2"	Carbon steel
⑥	Bushing	Sintered BR	—
⑦	Rubber bumper	Urethane	—
⑧	Snap ring	Spring steel	—
⑨	Piston seal	NBR	—
⑩	Piston gasket	NBR	—
⑪	Spring	Piano wire	Chromated
⑫	Spring guide	Aluminum alloy	Chromated

CJ1

CJP

CJ2

CM2

CG1

MB

MB1

CA2

CS1

C76

C85

C95

CP95

NCM

NCA

D-

-X

20-

Data

Series NCM

Dimensions: Double Acting, Single Rod

Double acting, single rod
Rod side nose mounting: NC(D)MB

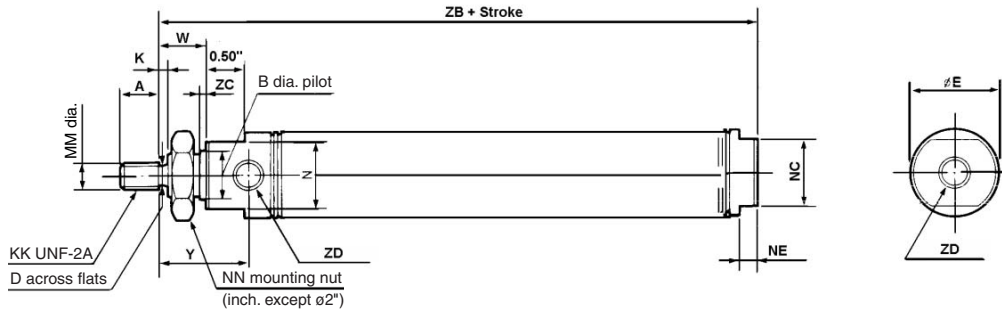

(in)

Bore size (in)	MM	KK	A	B	D	E	K	N	NC	NE	NN	W	Y	ZC	ZD	ZB No bumper	ZB Bumper
075 (3/4")	0.250	1/4-28	0.50	0.624	—	0.86	—	0.75	0.62	0.12	5/8-18	0.50	0.95	0.09	1/8 NPTF	2.97	2.97
088 (7/8")	0.250	1/4-28	0.50	0.624	—	0.93	—	0.75	0.75	0.18	5/8-18	0.50	0.95	0.09	1/8 NPTF	2.69	2.94
106 (1 1/16")	0.312	5/16-24	0.50	0.624	0.25	1.12	0.12	0.88	0.88	0.24	5/8-18	0.62	1.17	0.09	1/8 NPTF	3.25	3.38
125 (1 1/4")	0.437	7/16-20	0.75	0.749	0.38	1.32	0.25	1.06	1.06	0.25	3/4-16	0.88	1.62	0.09	1/8 NPTF	3.75	4.00
150 (1 1/2")	0.437	7/16-20	0.75	0.749	0.38	1.56	0.25	1.25	1.25	0.25	3/4-16	0.88	1.50	0.09	1/8 NPTF	3.69	3.82
200 (2")	0.625	1/2-20	0.88	1.374	0.50	2.06	0.38	1.75	1.75	0.31	1 1/4-12	1.19	1.19	0.12	1/4 NPTF	4.69	4.95

Double acting, single rod
Double end mounting: NC(D)ME

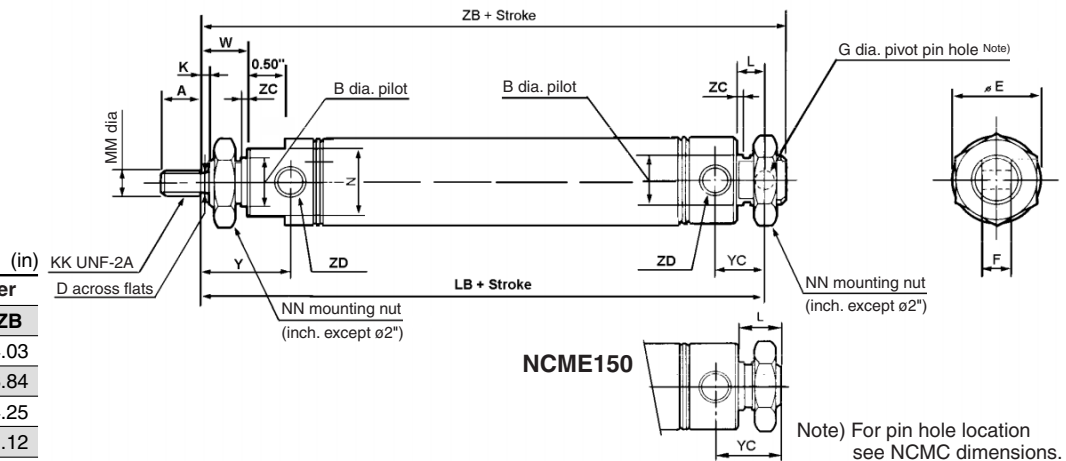

Bore (in)	No bumper		Bumper	
	LB	ZB	LB	ZB
075 (3/4")	3.75	4.03	3.75	4.03
088 (7/8")	3.31	3.59	3.56	3.84
106 (1 1/16")	3.84	4.12	3.97	4.25
125 (1 1/4")	4.47	4.87	4.72	5.12
150 (1 1/2")	—	4.5	—	4.63
200 (2")	5.62	6.06	5.88	6.32

(in)

Bore size (in)	MM	KK	A	B	D	E	F	G	K	L	N	NN	W	Y	YC	ZC	ZD
075 (3/4")	0.250	1/4-28	0.50	0.624	—	0.86	0.38	0.251	—	0.34	0.75	5/8-18	0.50	0.95	0.62	0.09	1/8 NPTF
088 (7/8")	0.250	1/4-28	0.50	0.624	—	0.93	0.38	0.251	—	0.34	0.75	5/8-18	0.50	0.95	0.62	0.09	1/8 NPTF
106 (1 1/16")	0.312	5/16-24	0.50	0.624	0.25	1.12	0.38	0.251	0.12	0.34	0.88	5/8-18	0.62	1.17	0.62	0.09	1/8 NPTF
125 (1 1/4")	0.437	7/16-20	0.75	0.749	0.38	1.32	0.50	0.251	0.25	0.41	1.06	3/4-16	0.88	1.62	0.78	0.09	1/8 NPTF
150 (1 1/2")	0.437	7/16-20	0.75	0.749	0.38	1.56	—	—	0.25	0.63	1.25	3/4-16	0.88	1.50	0.91	0.09	1/8 NPTF
200 (2")	0.625	1/2-20	0.88	1.374	0.50	2.06	0.75	0.375	0.38	0.56	1.75	1 1/4-12	1.19	1.91	1.03	0.12	1/4 NPTF

Dimensions: Double Acting, Single Rod

Double acting, single rod Head side pivot mounting: NC(D)MC

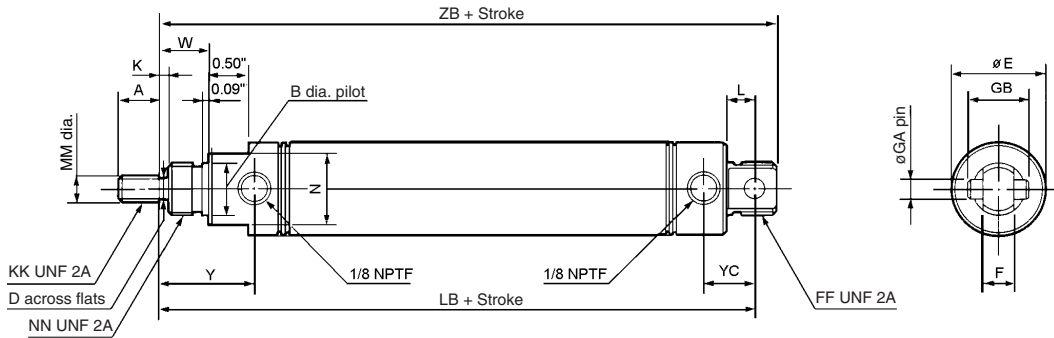

Bore size (in)	MM	KK	A	B	D	E	F	FF	GA	GB	K	L	N	NN	W	Y	YC	No bumper		Bumper	
																		LB	ZB	LB	ZB
075 (3/4")	0.250	1/4-28	0.50	0.624	—	0.86	0.38	5/8-18	0.250	0.75	—	0.34	0.75	5/8-18	0.50	0.95	0.62	3.75	4.03	3.75	4.03
088 (7/8")	0.250	1/4-28	0.50	0.624	—	0.93	0.38	5/8-18	0.250	0.75	—	0.34	0.75	5/8-18	0.50	0.95	0.62	3.31	3.59	3.56	3.84
106 (1 1/16")	0.312	5/16-24	0.50	0.624	0.25	1.12	0.38	5/8-18	0.250	0.75	0.12	0.34	0.88	5/8-18	0.62	1.17	0.62	3.84	4.12	3.97	4.25
125 (1 1/4")	0.437	7/16-20	0.75	0.749	0.38	1.32	0.50	5/8-18	0.250	0.75	0.25	0.41	1.06	3/4-16	0.88	1.62	0.78	4.47	4.87	4.72	5.12
150 (1 1/2")	0.437	7/16-20	0.75	0.749	0.38	1.56	0.62	—	0.375	1.00	0.25	0.50	1.25	3/4-16	0.88	1.50	0.78	4.38	4.75	4.51	4.88

Double acting, single rod Block mounting: NC(D)MR

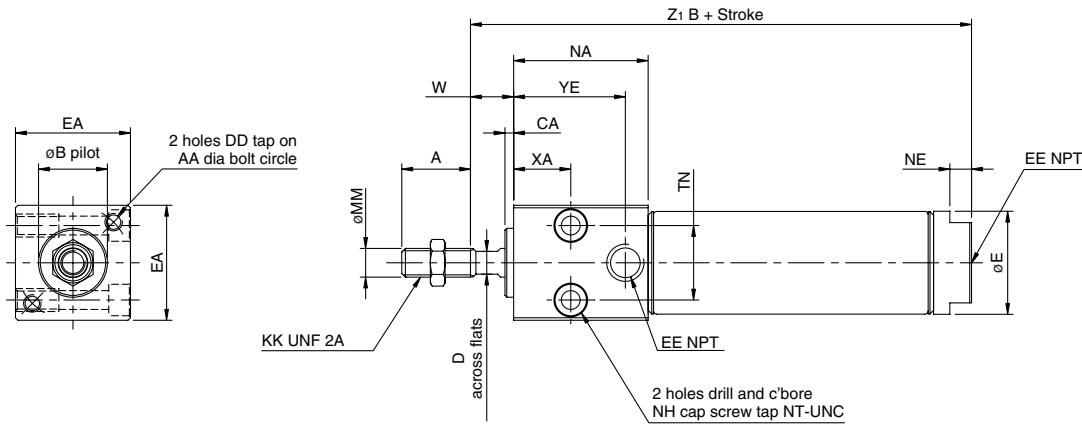

Bore size (in)	MM	KK	A	AA	B	CA	D	DD	E	EA	EE	NA	NE	NH	NT	TN	WF	YE	XA
106 (1 1/16")	0.312	3/16-24	0.75	1.25	0.750	0.093	0.25	10-32 UNF	1.12	1.25	1/8	1.47	0.24	10-32 UNF	1/4-20	0.81	0.47	1.22	0.62
150 (1 1/2")	0.437	7/16-20	1.25	1.75	1.00	0.125	0.38	1/4-20 NUC	1.56	1.75	1/4	1.93	0.25	1/4-20 NUC	5/16-18	1.12	0.38	1.57	0.88

Block Mounting Type

Bore	ZB1		ZB2		ZB3		ZC1		ZC2	
	No bumper	With bumper	No bumper	With bumper	No bumper	With bumper	No bumper	With bumper	No bumper	With bumper
075 (3/4")	3.22	3.22	2.66	2.66	2.35	2.35	1.69	1.69	2.69	2.69
106 (1 1/16")	3.75	3.88	3.38	3.51	2.93	3.06	1.81	1.94	2.81	2.94
150 (1 1/2")	4.19	4.32	3.69	3.82	3.69	3.82	2.00	2.13	3.00	3.13

Note) Length not affected by addition of magnet

CJ1

CJP

CJ2

CM2

CG1

MB

MB1

CA2

CS1

C76

C85

C95

CP95

NCM

NCA

D-

-X

20-

Data

Series NCM

Dimensions: Rod Boot

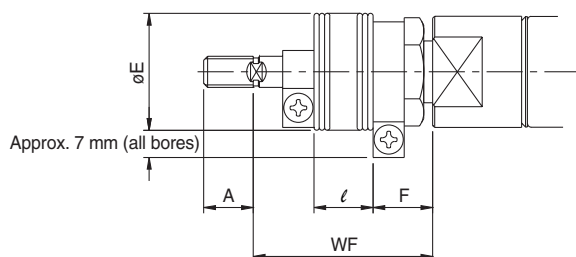

(in)

Bore size (in)	A	ϕe	f	Wf										
				0 to 2	2.1 to 4	4.1 to 6	6.1 to 8	8.1 to 10	8.1 to 10	12.1 to 14	14.1 to 16	16.1 to 20	20.1 to 24	24.1 to 28
075 (3/4")	0.50	1.18	0.51	1.81	2.31	2.81	3.31	3.81	4.31	4.81	5.31	—	—	—
088 (7/8")	0.50	1.18	0.51	1.81	2.31	2.81	3.31	3.81	4.31	4.81	5.31	—	—	—
106 (1 1/16")	0.50	1.18	0.51	1.81	2.31	2.81	3.31	3.81	4.31	4.81	5.31	—	—	—
125 (1 1/4")	0.75	1.38	0.55	1.94	2.44	2.94	3.44	3.94	4.44	4.94	5.44	6.44	7.44	8.44
150 (1 1/2")	0.75	1.38	0.55	1.94	2.44	2.94	3.44	3.94	4.44	4.94	5.44	6.44	7.44	8.44

(in)

Bore size (in)	l										
	0 to 2	2.1 to 4	4.1 to 6	6.1 to 8	8.1 to 10	8.1 to 10	12.1 to 14	14.1 to 16	16.1 to 20	20.1 to 24	24.1 to 28
075 (3/4")	0.50	1.00	1.50	2.00	2.50	3.00	3.50	4.00	—	—	—
088 (7/8")	0.50	1.00	1.50	2.00	2.50	3.00	3.50	4.00	—	—	—
106 (1 1/16")	0.50	1.00	1.50	2.00	2.50	3.00	3.50	4.00	—	—	—
125 (1 1/4")	0.50	1.00	1.50	2.00	2.50	3.00	3.50	4.00	5.00	6.00	7.00
150 (1 1/2")	0.50	1.00	1.50	2.00	2.50	3.00	3.50	4.00	5.00	6.00	7.00

Dimensions: Double Acting, Double Rod

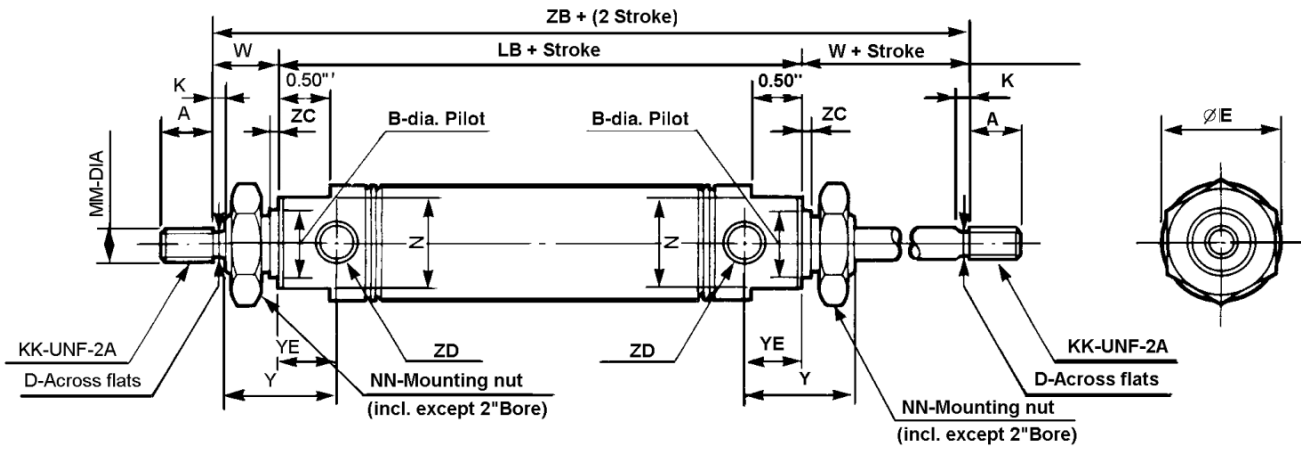

Bore size (in)	MM	KK	A	B	D	E	K	N	NN	W	Y	YE	ZC	ZD
075 (3/4")	0.250	1/4-28	0.50	0.624	—	0.86	—	0.75	5/8-18	0.50	0.95	0.45	0.09	1/8 NPTF
088 (7/8")	0.250	1/4-28	0.50	0.624	—	0.93	—	0.75	5/8-18	0.50	0.95	0.45	0.09	1/8 NPTF
106 (1 1/16")	0.312	5/16-24	0.50	0.624	0.25	1.12	0.12	0.88	5/8-18	0.62	1.05	0.55	0.09	1/8 NPTF
125 (1 1/4")	0.437	7/16-20	0.75	0.749	0.38	1.32	0.25	1.06	3/4-16	0.88	1.37	0.74	0.09	1/8 NPTF
150 (1 1/2")	0.437	7/16-20	0.75	0.749	0.38	1.56	0.25	1.25	3/4-16	0.88	1.25	0.62	0.09	1/8 NPTF
200 (2")	0.625	1/2-20	0.88	1.374	0.50	2.06	0.38	1.75	1 1/4-12	1.19	1.91	0.72	0.12	1/4 NPTF

Double Acting Double Rod

Bore	No bumper		Bumper	
	LB	ZB	LB	ZB
075 (3/4")	3.00	4.00	3.00	4.00
088 (7/8")	2.66	3.66	2.91	3.91
106 (1 1/16")	2.75	4.00	2.88	4.13
125 (1 1/4")	3.56	5.31	3.81	5.56
150 (1 1/2")	3.38	5.12	3.51	5.25
200 (2")	4.18	6.56	4.44	6.82

Note) Length not affected by addition of magnet except 106 bore.

Double Acting Double Rod with Magnet (106 bore)

Bore	No bumper		Bumper	
	LB	ZB	LB	ZB
106 (1 1/16")	3.13	4.38	3.25	4.50

CJ1

CJP

CJ2

CM2

CG1

MB

MB1

CA2

CS1

C76

C85

C95

CP95

NCM

NCA

D-

-X

20-

Data

Series NCM

Dimensions: Non-rotating Rod, Double Acting, Single Rod

Non-rotating rod

Rod side nose mounting: NC(D)MKB

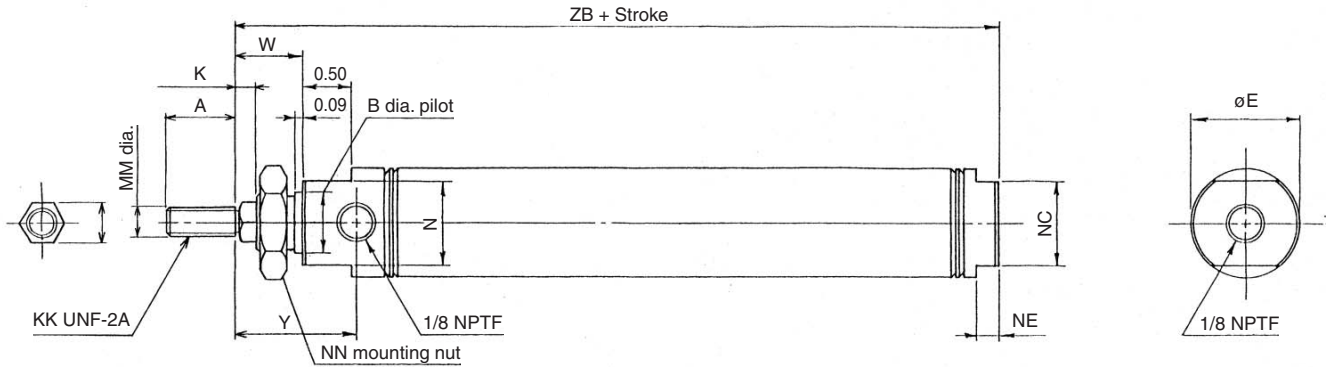

(in)

Bore size (in)	MM	KK	A	B	DA	E	K	N	NC	NE	NN	W	Y	ZB	
														No bumper	Bumper
075 (3/4")	0.250	1/4-28	0.50	0.624	0.25	0.86	0.25	0.75	0.62	0.12	5/8-18	0.75	1.20	3.22	3.32
088 (7/8")	0.250	1/4-28	0.50	0.624	0.25	0.93	0.25	0.75	0.75	0.18	5/8-18	0.75	1.20	2.94	3.19
106 (1 1/16")	0.312	5/16-24	0.50	0.624	0.38	1.12	0.25	0.88	0.88	0.24	5/8-18	0.75	1.30	3.38	3.52
125 (1 1/4")	0.375	3/8-24	0.88	0.749	0.44	1.32	0.25	1.06	1.06	0.25	3/4-16	0.88	1.62	3.75	4.00
150 (1 1/2")	0.375	3/8-24	0.88	0.874	0.44	1.56	0.38	1.25	1.25	0.25	7/8-14	1.12	1.81	4.00	4.13

Non-rotating rod

Double end mounting: NC(D)MKE

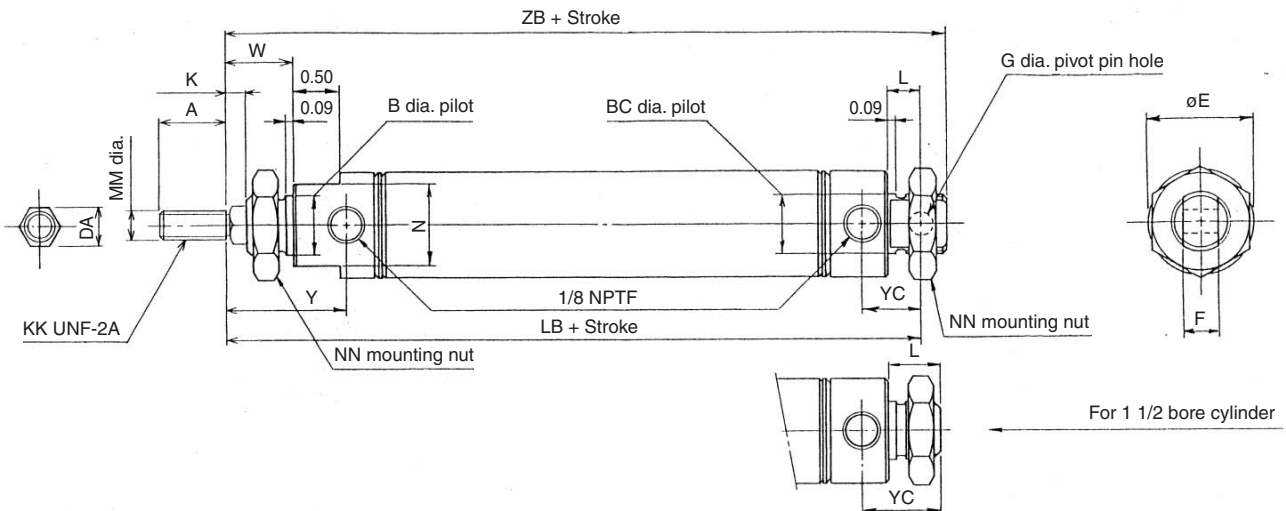

Bore size (in)	MM	KK	A	B	BC	DA	E	F	G	K	L	N	NN	W	Y	YC	Bumper			
																	LB	ZB	LB	ZB
075 (3/4")	0.250	1/4-28	0.50	0.624	0.624	0.25	0.86	0.38	0.251	0.25	0.34	0.75	5/8-18	0.75	1.20	0.62	4.00	4.28	4.00	4.28
088 (7/8")	0.250	1/4-28	0.50	0.624	0.624	0.25	0.93	0.38	0.251	0.25	0.34	0.75	5/8-18	0.75	1.20	0.62	3.55	3.83	3.81	4.09
106 (1 1/16")	0.312	5/16-24	0.50	0.624	0.624	0.38	1.12	0.38	0.251	0.25	0.34	0.88	5/8-18	0.75	1.30	0.62	3.97	4.25	4.11	4.39
125 (1 1/4")	0.375	3/8-24	0.88	0.749	0.749	0.44	1.32	0.50	0.251	0.25	0.41	1.06	3/4-16	0.88	1.62	0.78	4.46	4.86	4.72	5.12
150 (1 1/2")	0.375	3/8-24	0.88	0.874	0.749	0.44	1.56	—	—	0.38	0.63	1.25	7/8-14	1.12	1.81	0.91	—	4.81	—	4.94

Dimensions: Non-rotating Rod, Double Acting, Single Rod

Non-rotating rod
Head side pivot mounting: NC(D)MKC

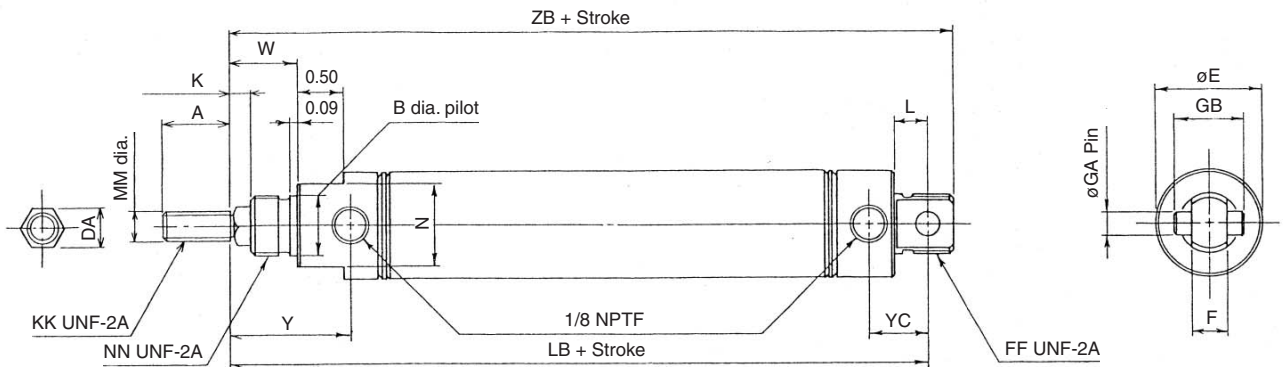

Bore size (in)	MM	KK	A	B	DA	E	F	FF	GA	GB	K	L	N	NN	W	Y	YC	No bumper		Bumper	
																		LB	ZB	LB	ZB
075 (3/4")	0.250	1/4-28	0.50	0.624	0.25	0.86	0.38	5/8-18	0.250	0.75	0.25	0.34	0.75	5/8-18	0.75	1.20	0.62	4.00	4.28	4.00	4.28
088 (7/8")	0.250	1/4-28	0.50	0.624	0.25	0.93	0.38	5/8-18	0.250	0.75	0.25	0.34	0.75	5/8-18	0.75	1.20	0.62	3.55	3.83	3.81	4.09
106 (1 1/16")	0.312	5/16-24	0.50	0.624	0.38	1.12	0.38	5/8-18	0.250	0.75	0.25	0.34	0.88	5/8-18	0.75	1.30	0.62	3.97	4.25	4.11	4.39
125 (1 1/4")	0.375	3/8-24	0.88	0.749	0.44	1.32	0.50	5/8-18	0.250	0.75	0.25	0.41	1.06	3/4-16	0.88	1.62	0.78	4.46	4.86	4.72	5.12
150 (1 1/2")	0.375	3/8-24	0.88	0.874	0.44	1.56	0.62	—	0.375	1.00	0.38	0.50	1.25	7/8-14	1.12	1.81	0.78	4.68	5.06	4.82	5.20

CJ1

CJP

CJ2

CM2

CG1

MB

MB1

CA2

CS1

C76

C85

C95

CP95

NCM

NCA

D-

-X

20-

Data

Series NCM

Dimensions: Single Acting, Single Return

Rod side nose mounting Spring return: NCMB□-□S

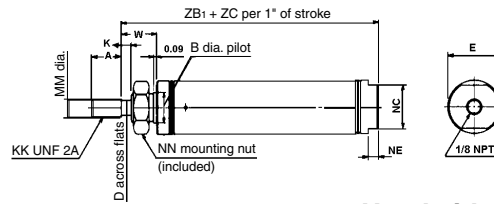

Double end mounting Spring return: NCME□-□S

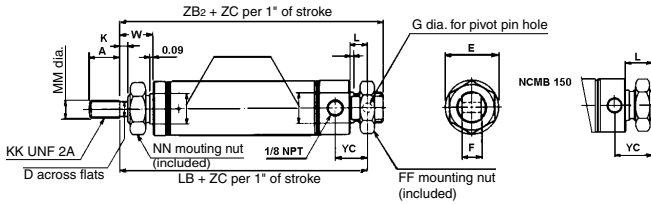

Head side pivot mounting Spring return: NCMC□-□S

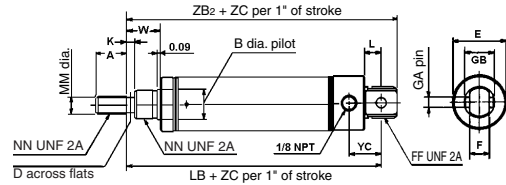

Bore size (in)	MM	KK	A	B	D	E	F	FF	G	GA	GB	K	NC	NE	NN	W	YC	ZC
075 (3/4")	0.250	1/4-28	0.50	0.496	—	0.86	0.38	5/8-18	0.251	0.250	0.75	—	0.62	0.12	1/2-20	0.44	0.62	1.69
088 (7/8")	0.250	1/4-28	0.50	0.624	—	0.93	0.38	5/8-18	0.251	0.250	0.75	—	0.75	0.18	5/8-18	0.50	0.62	1.56
106 (1 1/16")	0.312	5/16-24	0.50	0.624	0.25	1.12	0.38	5/8-18	0.251	0.250	0.75	0.12	0.88	0.24	5/8-18	0.62	0.62	1.56
125 (1 1/4")	0.437	7/16-20	0.75	0.749	0.38	1.32	0.50	3/4-16	0.251	0.250	0.75	0.25	1.06	0.25	3/4-16	0.88	0.78	1.81
150 (1 1/2")	0.437	7/16-20	0.75	0.749	0.38	1.56	0.62	3/4-16	0.376	0.375	1.00	0.25	1.25	0.25	3/4-16	0.88	0.78	1.69

Single Acting, Spring Return B, C, E Mounting without Magnet

Bore (in)	LB		ZB1		ZB2	
	No bumper	With bumper	No bumper	With bumper	No bumper	With bumper
075 (3/4")	2.28	2.28	1.50	1.50	2.56	2.56
088 (7/8")	2.22	2.47	1.59	1.84	2.50	2.75
106 (1 1/16")	2.66	2.79	2.06	2.19	2.94	3.07
125 (1 1/4")	3.13	3.38	2.41	2.66	3.53	3.78
150 (1 1/2")	3.12	3.25	2.44	2.57	3.50	3.63

Single Acting, Spring Return B, C Mounting with Magnet

Bore (in)	LB		ZB1		ZB2	
	No bumper	With bumper	No bumper	With bumper	No bumper	With bumper
075 (3/4")	2.41	1.53	1.63	1.75	2.69	2.81
088 (7/8")	2.47	2.59	1.84	1.97	2.75	2.88
106 (1 1/16")	2.79	2.91	2.19	2.32	3.06	3.19
125 (1 1/4")	3.38	3.50	2.66	2.78	3.79	3.91
150 (1 1/2")	3.25	3.38	2.56	2.68	3.63	3.75

Single Acting, Spring Return E Mounting with Magnet

Bore (in)	LB		ZB2	
	No bumper	With bumper	No bumper	With bumper
075 (3/4")	2.41	2.53	2.69	2.81
088 (7/8")	2.47	2.59	2.75	2.88
106 (1 1/16")	2.79	2.91	3.06	3.19
125 (1 1/4")	3.38	3.50	3.79	3.91
150 (1 1/2")	—	—	3.38	3.50

Single Acting, Spring Return Non-rotating B, C, E Mounting without Magnet

Bore (in)	LB		ZB1		ZB2		KK	MM
	No bumper	With bumper	No bumper	With bumper	No bumper	With bumper		
075 (3/4")	2.53	2.53	1.75	1.75	2.81	2.81	1/4-28	0.250
088 (7/8")	2.47	2.72	1.84	2.09	2.75	3.00	1/4-28	0.250
106 (1 1/16")	2.78	2.91	2.18	2.31	3.06	3.19	5/16-24	0.312
125 (1 1/4")	3.13	3.38	2.41	2.66	3.53	3.78	3/8-24	0.375
150 (1 1/2")	3.25	3.37	2.57	2.69	3.63	3.75	3/8-24	0.375

Dimensions: Single Acting, Spring Extend

Rod side nose mounting Spring extend: NCMB□-□T

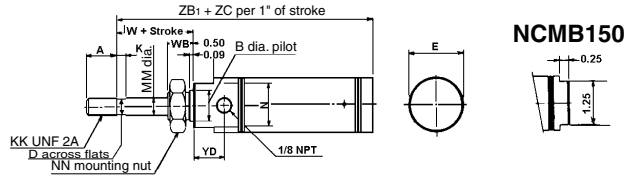

Double end mounting Spring extend: NCME□-□T

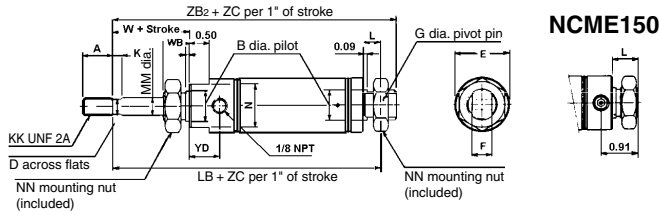

Head side pivot mounting Spring extend: NCMC□-□T

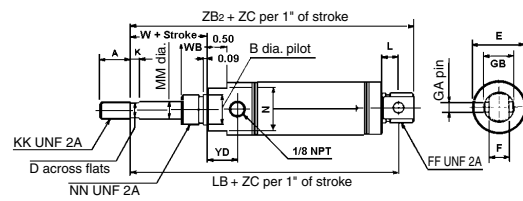

Bore size (in)	MM	KK	A	B	D	E	F	FF	G	GA	GB	K	LB	N	NN	W	WB	YD	ZC
075 (3/4")	0.250	1/4-28	0.50	0.624	—	0.86	0.38	5/8-18	0.251	0.250	0.75	—	2.44	0.75	5/8-18	0.50	0.50	0.45	2.69
088 (7/8")	0.250	1/4-28	0.50	0.624	—	0.93	0.38	5/8-18	0.251	0.250	0.75	—	2.62	0.75	5/8-18	0.50	0.50	0.45	2.56
106 (1 1/16")	0.312	5/16-24	0.50	0.624	0.25	1.12	0.38	5/8-18	0.251	0.250	0.75	0.12	2.78	0.88	5/8-18	0.62	0.50	0.55	2.81
125 (1 1/4")	0.437	7/16-20	0.75	0.749	0.38	1.32	0.50	3/4-16	0.251	0.250	0.75	0.25	3.76	1.06	3/4-16	0.88	0.62	0.75	2.81
150 (1 1/2")	0.437	7/16-20	0.75	0.749	0.38	1.56	0.62	—	—	0.375	1.00	0.25	3.88	1.25	3/4-16	0.88	0.62	0.63	3.00

Single Acting, Spring Extend B, C, E Mounting without Magnet

Bore (in)	LB		ZB1		ZB2	
	No bumper	With bumper	No bumper	With bumper	No bumper	With bumper
075 (3/4")	2.44	2.44	2.10	2.10	2.72	2.72
088 (7/8")	2.37	2.62	2.02	2.27	2.66	2.91
106 (1 1/16")	2.78	2.91	2.42	2.55	3.06	3.19
125 (1 1/4")	3.51	3.76	3.09	3.34	3.91	4.16
150 (1 1/2")	3.88	4.01	3.16	3.29	4.26	4.39

Single Acting, Spring Extend B, C, E Mounting with Magnet

Bore (in)	LB		ZB1		ZB2	
	No bumper	With bumper	No bumper	With bumper	No bumper	With bumper
075 (3/4")	2.56	2.69	2.23	2.36	2.85	2.97
088 (7/8")	2.62	2.75	2.27	2.40	2.91	3.03
106 (1 1/16")	2.91	3.03	2.55	2.68	3.19	3.31
125 (1 1/4")	3.76	3.88	3.34	3.47	4.19	4.29
150 (1 1/2")	4.00	4.12	3.29	3.41	4.38	4.50

Single Acting, Spring Extend E Mounting with Magnet

Bore (in)	LB		ZB2	
	No bumper	With bumper	No bumper	With bumper
075 (3/4")	2.56	2.69	2.85	2.97
088 (7/8")	2.62	2.75	2.91	3.03
106 (1 1/16")	2.91	3.03	3.19	3.31
125 (1 1/4")	3.76	3.88	4.16	4.21
150 (1 1/2")	—	—	4.12	4.25

CJ1

CJP

CJ2

CM2

CG1

MB

MB1

CA2

CS1

C76

C85

C95

CP95

NCM

NCA

D-

-X

20-

Data

Series NCM

Mounting Bracket Accessory

Foot bracket

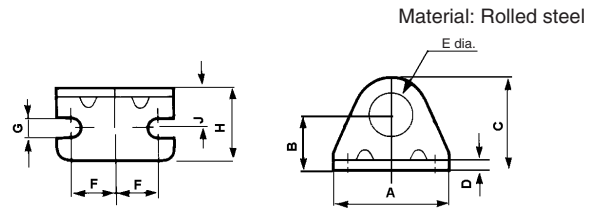

(in)

Part no.	Applicable bore	A	B	C	D	E	F	G	H	J
NCM-L075*	3/4", 7/8", 1 1/16"	1.89	0.81	1.36	0.12	0.63	0.75	0.27	0.98	0.56
NCM-L150	1 1/4", 1 1/2"	2.52	1.00	1.75	0.12	0.75	0.94	0.27	1.50	0.75
NCMK-L150	1 1/4", 1 1/2"	2.52	1.00	1.75	0.12	0.88	0.94	0.27	1.50	0.75
NCM-L200	2"	3.126	1.5	2.5	0.25	1.38	1.13	0.34	1.63	1.00

Note) NCM-L075 will not fit NCM*075*S (Single Acting). For this option use: NCM075-19-51046.
(F dimension=0.51")

Rod clevis

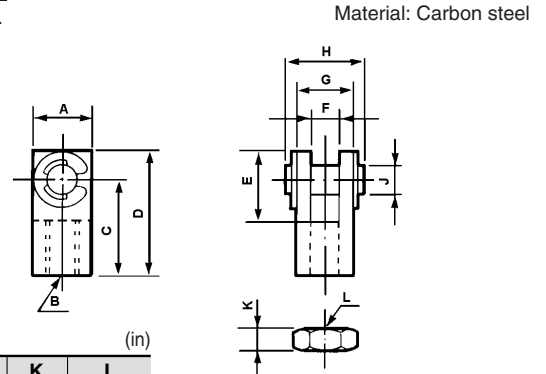

(in)

Part no.	Applicable bore	A	B	C	D	E	F	G	H	J	K	L
NY-075	3/4", 7/8"	0.51	1/4-28	0.94	1.18	0.69	0.25	0.51	0.71	0.25	0.16	1/4-28
NY-106	1 1/16"	0.51	5/16-24	0.94	1.18	0.69	0.25	0.51	0.71	0.25	0.19	5/16-24
NY-125	1 1/4", 1 1/2"	0.75	7/16-20	1.31	1.69	0.94	0.38	0.75	1.02	0.38	0.25	7/16-20
NY-G050	2"	0.75	1/2-20	1.32	1.69	0.94	0.38	0.75	1.02	0.38	0.31	1/2-20

Jam nut (Rod thread)

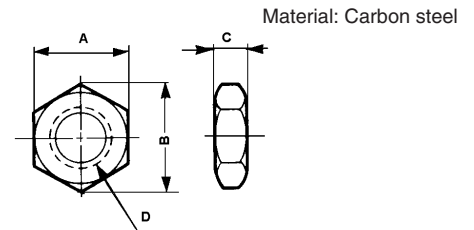

(in)

Part no.	Applicable bore	A	B	C	D
JM-025	3/4", 7/8"	0.44	0.51	0.16	1/4-28 UNF
JM-03	1 1/16"	0.50	0.50	0.19	5/16-24 UNF
JM-045	1 1/4", 1 1/2"	0.69	0.79	0.26	7/16-20 UNF
JM-04	1 1/4", 1 1/2" (Non-rotating)	0.56	0.65	0.23	3/8-24 UNF
JM-05	2"	0.75	0.87	0.32	1/2-20 UNF

Mounting Bracket Accessory

Material: Rolled steel

Pivot bracket (Head side pivot): NCMC

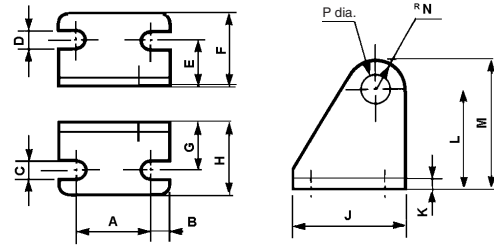

Part no.	Applicable bore	A	B	C	D	E	F	G	H	J	K	L	M	N	øP
NCM-PC075	3/4", 7/8", 1 1/16", 1 1/4"	0.75	0.18	0.27	0.27	0.44	0.79	0.44	0.79	1.101	0.12	0.88	1.18	0.31	0.255
NCM-PC150	1 1/2"	1	0.25	0.27	0.27	0.62	0.98	0.62	0.98	0.50	0.12	1.38	1.75	0.38	0.38

Pivot bracket (End mount): NCME

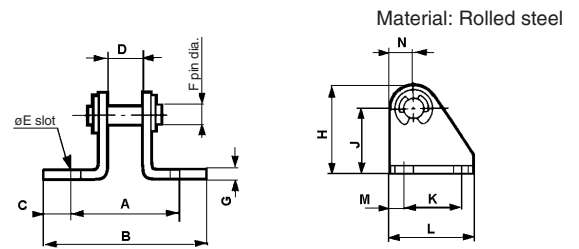

Part no.	Applicable bore	A	B	C	D	øE	F	G	H	J	K	L	M	N
NCM-PE075	3/4", 7/8", 1 1/16"	1.25	1.95	0.35	0.38	0.27	0.25	0.12	1.18	0.88	0.75	1.10	0.18	0.31
NCM-PE125	1 1/4", 1 1/2"	1.38	2.08	0.35	0.50	0.27	0.25	0.12	1.18	0.88	0.75	1.10	0.18	0.31
NCG-PC050	2"	2.12	3.00	0.44	0.75	0.27	0.38	0.24	1.75	1.38	1.00	1.50	0.25	0.37

Mounting nut (Nose mount thread)

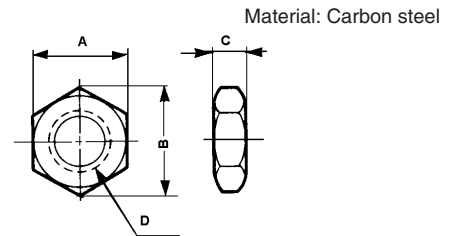

Part no.	Applicable bore	A	B	C	D
JM-08	3/4", 7/8", 1 1/16"	0.94	1.08	0.38	5/8-18 UNF
JM-10	1 1/4", 1 1/2"	1.12	1.30	0.42	3/4-16 UNF
JM-14	2"	1.61	1.86	0.43	1 1/4 -12 UNF

CJ1

CJP

CJ2

CM2

CG1

MB

MB1

CA2

CS1

C76

C85

C95

CP95

NCM

NCA

D-

-X

20-

Data

Series NCM

Double Acting/Single Rod/Band Mounting Auto Switch Mounting Position and Mounting Height

D-C7/C8

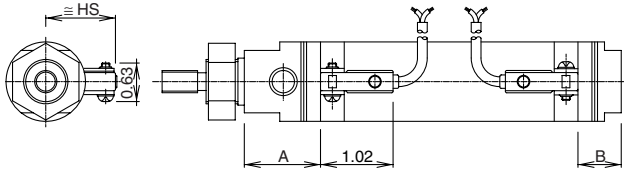

D-H7□/H7□W/H7□F/H7BAL□

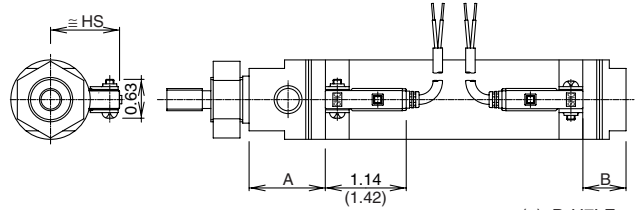

D-B5/B6/B59W

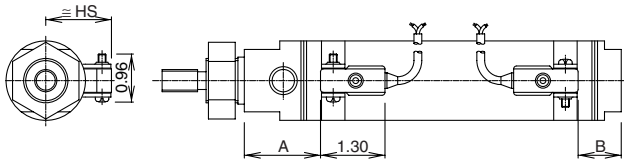

D-G59/K59

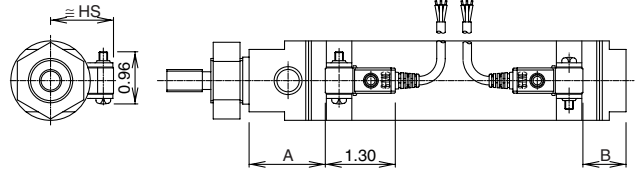

* () : D-H7LF

D-C73C/C80C

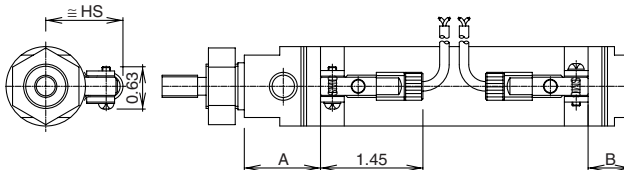

D-H7C

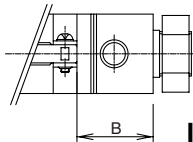
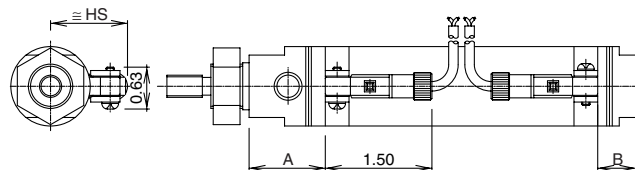

In case of NCDMC, NCDME

Auto Switch Mounting Position (NCDMB) (in)

Auto switch model	D-B5 D-B6		D-C7□ D-C80 D-C73C D-C80C		D-B59W		D-H7□ D-H7C D-H7□W D-H7BAL D-H7NF		D-H7LF		D-G59 D-K59	
	A	B	A	B	A	B	A	B	A	B	A	B
075 (3/4")	0.88	0.37	1.12	0.60	1.00	0.48	1.08	0.56	1.02	0.50	0.94	0.42
088 (7/8")	0.72	0.25	0.96	0.49	0.84	0.37	0.92	0.45	0.86	0.39	0.78	0.31
106 (1 1/16")	0.94	0.46	1.18	0.70	1.06	0.58	1.14	0.66	1.08	0.60	1.00	0.52
125 (1 1/4")	1.17	0.46	1.41	0.69	1.29	0.57	1.37	0.65	1.31	0.59	1.23	0.51
150 (1 1/2")	1.07	0.50	1.31	0.74	1.19	0.61	1.27	0.70	1.21	0.64	1.13	0.56
200 (2")	1.52	0.77	1.75	1.01	1.63	0.88	1.72	0.97	1.66	0.91	1.58	0.83

Auto Switch Mounting Position (NCDMC, NCDME) (in)

Auto switch model	D-B5 D-B6		D-C7□ D-C80 D-C73C D-C80C		D-B59W		D-H7□ D-H7C D-H7□W D-H7BAL D-H7NF		D-H7LF		D-G59 D-K59	
	A	B	A	B	A	B	A	B	A	B	A	B
075 (3/4")	0.88	0.80	1.12	1.03	1.00	0.91	1.08	1.00	1.02	0.94	0.94	0.86
088 (7/8")	0.72	0.53	0.96	0.76	0.84	0.64	0.92	0.72	0.86	0.66	0.78	0.59
106 (1 1/16")	0.94	0.70	1.18	0.94	1.06	0.81	1.14	0.90	1.08	0.84	1.00	0.76
125 (1 1/4")	1.17	0.79	1.41	1.02	1.29	0.90	1.37	0.98	1.31	0.92	1.23	0.85
150 (1 1/2")	1.07	0.70	1.31	0.93	1.19	0.81	1.27	0.89	1.21	0.83	1.13	0.75
200 (2")	1.52	1.14	1.75	1.38	1.63	1.25	1.72	1.34	1.66	1.28	1.58	1.20

Auto Switch Mounting Position (NCDMB-*C) (in)

Auto switch model	D-B5 D-B6		D-C7□ D-C80 D-C73C D-C80C		D-B59W		D-H7□ D-H7C D-H7□W D-H7BAL D-H7NF		D-H7LF		D-G59 D-K59	
	A	B	A	B	A	B	A	B	A	B	A	B
075 (3/4")	0.92	0.35	1.16	0.58	1.03	0.46	1.12	0.54	1.06	0.48	0.98	0.40
088 (7/8")	0.85	0.38	1.09	0.62	0.97	0.50	1.05	0.58	0.99	0.52	0.91	0.44
106 (1 1/16")	1.07	0.59	1.31	0.83	1.19	0.71	1.27	0.79	1.21	0.73	1.13	0.65
125 (1 1/4")	1.30	0.59	1.54	0.82	1.42	0.70	1.50	0.78	1.44	0.72	1.36	0.64
150 (1 1/2")	1.20	0.63	1.44	0.87	1.32	0.74	1.40	0.83	1.34	0.77	1.26	0.69
200 (2")	1.65	0.90	1.88	1.14	1.76	1.01	1.85	1.10	1.79	1.04	1.71	0.96

Auto Switch Mounting Position (NCDMC-*C, NCDME-*C) (in)

Auto switch model	D-B5 D-B6		D-C7□ D-C80 D-C73C D-C80C		D-B59W		D-H7□ D-H7C D-H7□W D-H7BAL D-H7NF		D-H7LF		D-G59 D-K59	
	A	B	A	B	A	B	A	B	A	B	A	B
075 (3/4")	0.92	0.78	1.16	1.01	1.03	0.89	1.12	0.98	1.06	0.92	0.98	0.84
088 (7/8")	0.85	0.66	1.09	0.89	0.97	0.77	1.05	0.85	0.99	0.79	0.91	0.72
106 (1 1/16")	1.07	0.83	1.31	1.07	1.19	0.94	1.27	1.03	1.21	0.97	1.13	0.89
125 (1 1/4")	1.30	0.92	1.54	1.15	1.42	1.03	1.50	1.11	1.44	1.05	1.36	0.98
150 (1 1/2")	1.20	0.83	1.44	1.06	1.32	0.94	1.40	1.02	1.34	0.96	1.26	0.88
200 (2")	1.65	1.27	1.88	1.51	1.76	1.38	1.85	1.47	1.79	1.41	1.71	1.33

Mounting Height (NCDM) (in)

Auto switch model	D-B5 D-B6 D-B59W D-H7C D-G59 D-K59		D-C7□ D-C80 D-H7□ D-H7□W D-H7BAL D-H7□F		C-C73C D-C80C	
	≅ HS		≅ HS		≅ HS	
075 (3/4")	0.98		0.87		0.96	
088 (7/8")	1.04		0.93		1.02	
106 (1 1/16")	1.14		0.98		1.12	
125 (1 1/4")	1.24		1.08		1.22	
150 (1 1/2")	1.36		1.20		1.34	
200 (2")	1.61		1.46		1.59	

Double Acting/Single Rod/Band Mounting Auto Switch Mounting Position and Mounting Height

D-C7/C8

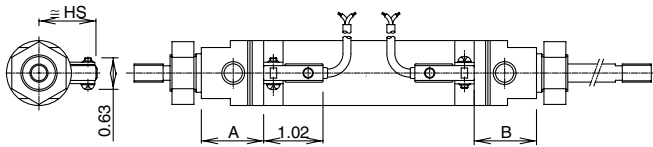

D-H7□/H7□W/H7□F/H7BAL□

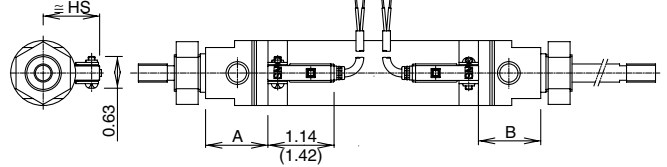

* () : D-H7LF

D-B5/B6/B59W

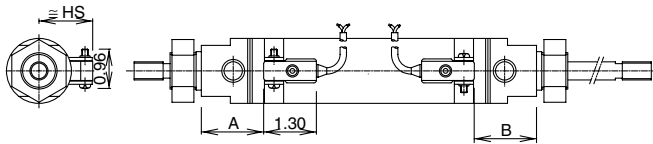

D-G59/K59

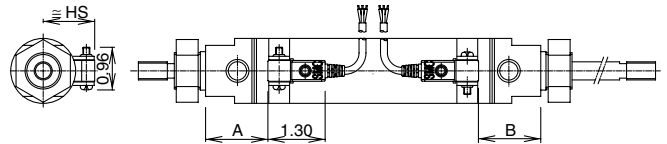

D-C73C/C80C

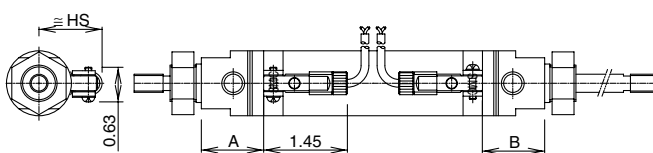

D-H7C

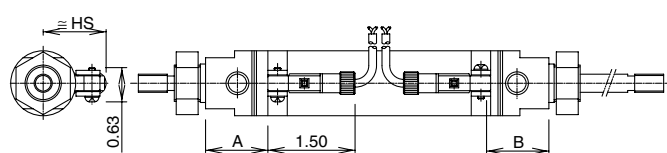

Auto Switch Mounting Position (NCDMW) (in)

Auto switch model	D-B5 D-B6		D-C7□ D-C80 D-C73C D-C80C		D-B59W		D-H7□ D-H7C D-H7□W D-H7BAL D-H7NF		D-H7LF		D-G59 D-K59	
	A	B	A	B	A	B	A	B	A	B	A	B
075 (3/4")	0.88	0.89	1.12	1.13	1.00	1.00	1.08	1.09	1.02	1.03	0.94	0.95
088 (7/8")	0.72	0.72	0.96	0.95	0.84	0.83	0.92	0.91	0.86	0.85	0.78	0.77
106 (1 1/16")	0.94	0.95	1.18	1.18	1.06	1.06	1.14	1.14	1.08	1.09	1.00	1.01
125 (1 1/4")	1.17	1.14	1.41	1.38	1.29	1.26	1.37	1.34	1.31	1.28	1.23	1.20
150 (1 1/2")	1.07	1.07	1.31	1.31	1.19	1.18	1.27	1.27	1.21	1.21	1.13	1.13
200 (2")	1.52	1.45	1.75	1.69	1.63	1.57	1.72	1.65	1.66	1.59	1.58	1.51

Auto Switch Mounting Position (NCDMW-*C) (in)

Auto switch model	D-B5 D-B6		D-C7□ D-C80 D-C73C D-C80C		D-B59W		D-H7□ D-H7C D-H7□W D-H7BAL D-H7NF		D-H7LF		D-G59 D-K59	
	A	B	A	B	A	B	A	B	A	B	A	B
075 (3/4")	0.92	0.87	1.16	1.11	1.03	0.98	1.12	1.07	1.06	1.01	0.98	0.93
088 (7/8")	0.85	0.85	1.09	1.08	0.97	0.96	1.05	1.04	0.99	0.98	0.91	0.90
106 (1 1/16")	1.07	1.08	1.31	1.31	1.19	1.19	1.27	1.27	1.21	1.22	1.13	1.14
125 (1 1/4")	1.30	1.27	1.54	1.51	1.42	1.39	1.50	1.47	1.44	1.41	1.36	1.33
150 (1 1/2")	1.20	1.20	1.44	1.44	1.32	1.31	1.40	1.40	1.34	1.34	1.26	1.26
200 (2")	1.65	1.58	1.88	1.82	1.76	1.70	1.85	1.78	1.79	1.72	1.71	1.64

Mounting Height (NCDM) (in)

Auto switch model	D-B5 D-B6 D-B59W D-H7C D-G59 D-K59		D-C7□ D-C80 D-H7□ D-H7□W D-H7BAL D-H7□F		C-C73C D-C80C	
	≅ HS		≅ HS		≅ HS	
075 (3/4")	0.98		0.87		0.96	
088 (7/8")	1.04		0.93		1.02	
106 (1 1/16")	1.14		0.98		1.12	
125 (1 1/4")	1.24		1.08		1.22	
150 (1 1/2")	1.36		1.20		1.34	
200 (2")	1.61		1.46		1.59	

CJ1

CJP

CJ2

CM2

CG1

MB

MB1

CA2

CS1

C76

C85

C95

CP95

NCM

NCA

D-

-X

20-

Data

Series NCM

Double Acting/Single Rod/Band Mounting Auto Switch Mounting Position and Mounting Height

D-C7/C8

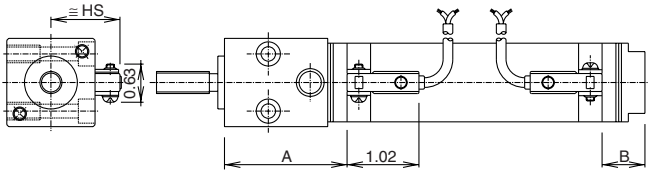

D-H7□/H7□W/H7□F/H7BAL□

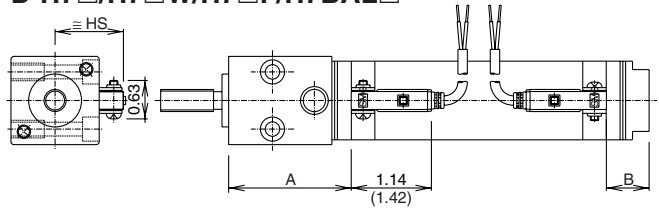

D-B5/B6/B59W

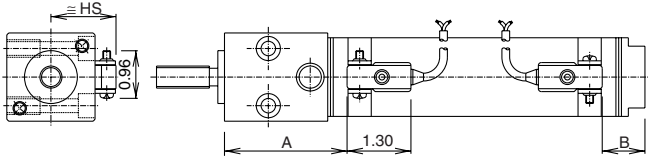

D-G59/K59

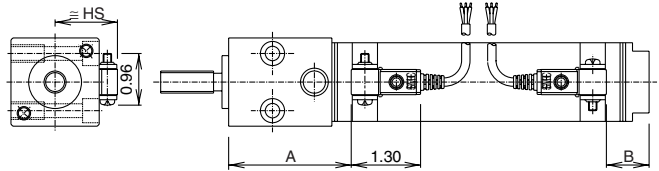

* (): D-H7LF

D-C73C/C80C

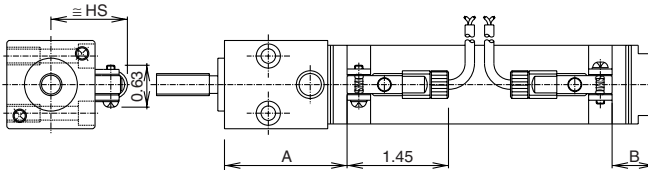

D-H7C

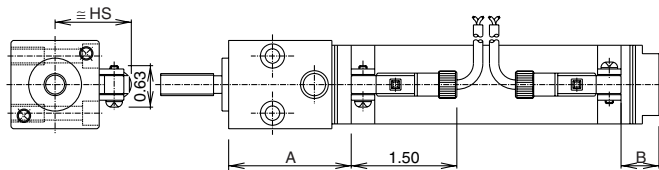

Auto Switch Mounting Position (NCDMR) (in)

Auto switch model	D-B5 D-B6		D-C7□ D-C80 D-C73C D-C80C		D-B59W		D-H7□ D-H7C D-H7□W D-H7BAL D-H7NF		D-H7LF		D-G59 D-K59	
	A	B	A	B	A	B	A	B	A	B	A	B
075 (3/4")	1.30	0.37	1.54	0.60	1.42	0.48	1.50	0.56	1.44	0.50	1.36	0.42
106 (1 1/16")	1.61	0.46	1.85	0.70	1.72	0.58	1.81	0.66	1.75	0.60	1.67	0.52
150 (1 1/2")	2.10	0.50	2.33	0.74	2.21	0.61	2.29	0.70	2.24	0.64	2.16	0.56

Auto Switch Mounting Position (NCDMR-*C) (in)

Auto switch model	D-B5 D-B6		D-C7□ D-C80 D-C73C D-C80C		D-B59W		D-H7□ D-H7C D-H7□W D-H7BAL D-H7NF		D-H7LF		D-G59 D-K59	
	A	B	A	B	A	B	A	B	A	B	A	B
075 (3/4")	1.30	0.37	1.54	0.60	1.42	0.48	1.50	0.56	1.44	0.50	1.36	0.42
106 (1 1/16")	1.61	0.46	1.85	0.70	1.72	0.58	1.81	0.66	1.75	0.60	1.67	0.52
150 (1 1/2")	2.10	0.50	2.33	0.74	2.21	0.61	2.29	0.70	2.24	0.64	2.16	0.56

Mounting Height (NCDM) (in)

Auto switch model	D-B5 D-B6 D-B59W D-H7C D-G59 D-K59		D-C7□ D-C80 D-H7□ D-H7□W D-H7BAL D-H7□F		C-C73C D-C80C	
	≅ HS		≅ HS		≅ HS	
075 (3/4")	0.98		0.87		0.96	
088 (7/8")	1.04		0.93		1.02	
106 (1 1/16")	1.14		0.98		1.12	
125 (1 1/4")	1.24		1.08		1.22	
150 (1 1/2")	1.36		1.20		1.34	
200 (2")	1.61		1.46		1.59	