

TSLOTS Hardware

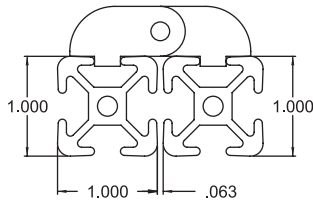

10 Series

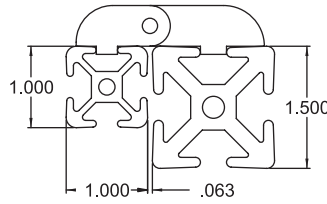

10 to 15 Series

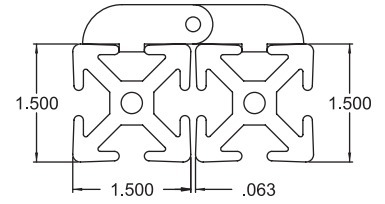

15 Series

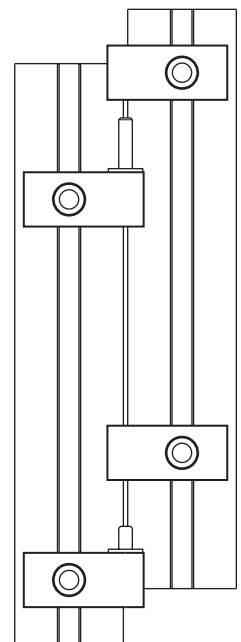
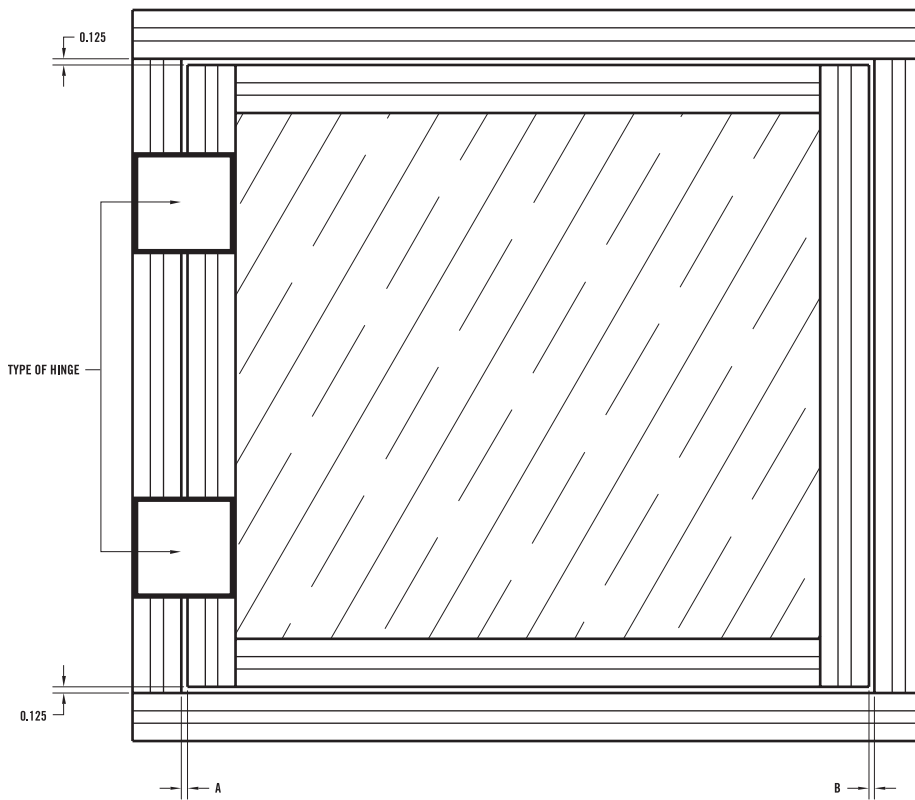

HINGE TYPE	DIMENSION A	DIMENSION B
15 S Lift Off Hinge Assembly	.063"	.187"
10 S Lift Off Hinge Assembly	.063"	.187"
10 S to 15 S Lift Off Hinge Assembly	.063"	.187"
15 S Aluminum Hinge (655082)	.125"	.125"
10 S Aluminum Hinge (655083)	.063"	.187"
10 S to 15 S Aluminum Hinge (655081)	.125"	.125"

* Note: For all doors, make the door .25" smaller in height and width than the door frame.

LIFT OFF HINGES



10 SERIES - LIFT OFF HINGES 10S 25S

ITEM #	DESCRIPTION
655070	10 S Right Hand Lift-Off Hinge w/ Long Pin
655071	10 S Left Hand Lift-Off Hinge w/ Long Pin
655072	10 S Right Hand Lift-Off Hinge w/ Short Pin
655073	10 S Left Hand Lift-Off Hinge w/ Short Pin
655074	10 S Lift-Off Hinge Section w/ Bushing
655075	10 S Lift-Off Hinge w/ Two Pins

15 SERIES - LIFT OFF HINGES 15S

ITEM #	DESCRIPTION
655089	15 S Right Hand Lift-Off Hinge w/ Long Pin
655090	15 S Left Hand Lift-Off Hinge w/ Long Pin
655091	15 S Right Hand Lift-Off Hinge w/ Short Pin
655092	15 S Left Hand Lift-Off Hinge w/ Short Pin
655093	15 S Lift-Off Hinge w/ Bushing
655094	15 S Lift-Off Hinge w/ Two Pins

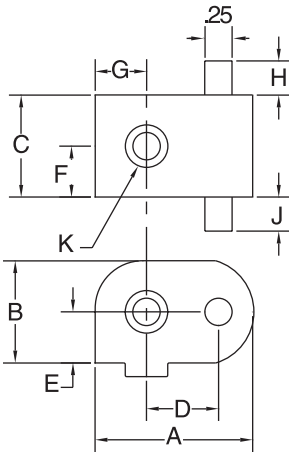

ITEM #	LBS	A	B	C	D	E	F	G	H	J	K
655070	0.06	1.156	0.500	0.750	0.529	0.250	0.375	0.377	N/A	N/A	10-32
655071	0.06	1.156	0.500	0.750	0.529	0.250	0.375	0.377	0.36	0.36	10-32
655072	0.055	1.156	0.500	0.750	0.529	0.250	0.375	0.377	N/A	N/A	10-32
655073	0.055	1.156	0.500	0.750	0.529	0.250	0.375	0.377	0.36	0.36	10-32
655074	0.065	1.156	0.500	0.750	0.529	0.250	0.375	0.377	N/A	N/A	10-32
655075	0.050	1.156	0.500	0.750	0.529	0.250	0.375	0.377	0.36	0.36	10-32
655089	0.085	1.655	0.500	0.750	0.780	0.250	0.375	0.625	N/A	0.750	1/4-20
655090	0.085	1.655	0.500	0.750	0.780	0.250	0.375	0.625	0.36	N/A	1/4-20
655091	0.080	1.655	0.500	0.750	0.780	0.250	0.375	0.625	N/A	0.36	1/4-20
655092	0.080	1.655	0.500	0.750	0.780	0.250	0.375	0.625	0.36	N/A	1/4-20
655093	0.090	1.655	0.500	0.750	0.780	0.250	0.375	0.625	N/A	N/A	1/4-20
655094	0.075	1.655	0.500	0.750	0.780	0.250	0.375	0.625	0.36	0.36	1/4-20

LIFT OFF HINGE ASSEMBLIES

		INDIVIDUAL PART NUMBER											
		655070	655071	655072	655073	655074	655075	655089	655090	655091	655092	655093	655094
ASSEMBLY PART NUMBER	655062	1		1		2							
	655063		1		1	2							
	655064			1	1	1							
	655100							1		1		2	
	655101								1		1	2	
	655102									1	1	1	
	TRANSITION HINGES												
655097					2		1		1				
655098					2			1		1			
655099					1				1	1			

TSLOTS Hardware

UNIVERSAL DOOR HINGE



ITEM # DESCRIPTION
 655768 10 S & 15 S Universal Die Cast Hinge w/ Oblong Holes 10S 15S 25S 40S

10S RECOMMENDED FASTENERS

DESCRIPTION	ITEM #
1/4"-20 x 5/8" BHSCS & Economy T-Nut	651023 & 651163
M6 x 16mm BHSCS & Economy T-Nut	651335 & 651386

15S RECOMMENDED FASTENERS

DESCRIPTION	ITEM #
5/16"-18 x 3/4" SHCS & Economy T-Nut	651213
M8 x 20mm SHCS & Economy T-Nut	651346 & 651367

LIFT OFF HINGES



LIFT OFF HINGES 10S 25S

ITEM #	DESCRIPTION
655771	10 S Right Hand Lift-Off Hinge
655770	10 S Left Hand Lift-Off Hinge

LIFT OFF HINGES 15S 40S

ITEM #	DESCRIPTION
655774	15 S Right Hand Lift-Off Hinge w/ Long Pin
655773	15 S Left Hand Lift-Off Hinge w/ Long Pin

- Black, fiberglass reinforced nylon with stainless steel bolt
- FHSCS screw and nut combo recommended
- 651185 for 10S hinges
- 651545 for 15S hinges



ITEM #	A1	A2	B1	B2
655770	.590	.590	1.023	1.023
655771	.590	.590	1.023	1.023
655774	.787	.787	1.397	1.397
655773	.787	.787	1.397	1.397

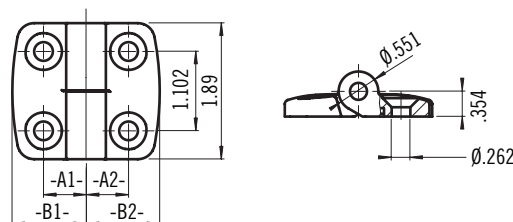

PLASTIC HINGES ADJUSTABLE



ITEM #	DESCRIPTION
655077	15 S Black Adjustable Hinge 15S 40S
655078	10 S Black Adjustable Hinge 10S 25S

RECOMMENDED BOLT ASSEMBLY TO EXTRUSION

QTY	ITEM #
2	651023 & 651105 (for 655077)
2	651204 (for 655078)

RECOMMENDED BOLT ASSEMBLY TO 1/4" PANEL

QTY	ITEM #
2	651216 & 651105 (for 655077)
2	651206 (for 655078)

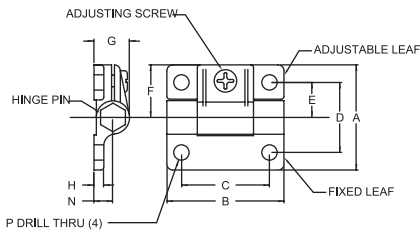

- Allows you to mount plastic panels and doors directly to TSLOTS
- Adjustable hinge allows you to increase or decrease pivot tension
- Adjustable Hinges are not suitable for hinging two TSLOTS extrusions together
- 10 and 15 Series sizes

ITEM #	A	B	C	D	E	F	G	H	N	P
655077	2.25	2.50	1.88	1.50	0.75	1.125	.770	.200	.410	.270
655078	1.44	1.69	1.25	1.00	0.50	0.72	.500	.230	.270	.197

PLASTIC HINGES



ITEM #	DESCRIPTION
655679	10 S Heavy Duty Plastic Hinge 10S 25S
655680	15 S Heavy Duty Plastic Hinge 15S 40S
655772	10 S to 15 S Heavy Duty Transition Hinge 10S 15S 25S 40S

RECOMMENDED BOLT ASSEMBLY

QTY	ITEM #
4	651185 (for 655679)
4	651180 & 651322 (for 655680)
2	651185 & 651180 & 651322 (for 655772)

- Black fiberglass reinforced nylon, stainless steel bolt
- Hinges TSLOTS Extrusions together
- 10 and 15 Series sizes

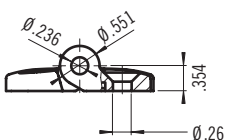
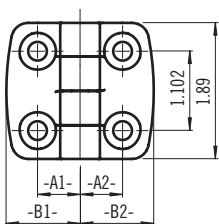

ITEM #	A1	A2	B1	B2
655679	.590	.590	1.023	1.023
655772	.590	.787	1.023	1.397
655680	.787	.787	1.397	1.397

TSLOTS Hardware

ALUMINUM HINGE



ITEM #	DESCRIPTION
655083	10 S Aluminum Hinge 10S 25S
655081	10 To 15 S Aluminum Transition Hinge
655082	15 S Aluminum Hinge 15S 40S

RECOMMENDED BOLT ASSEMBLY

QTY	ITEM #
4	(4) 651166 (For #655083)
4	(2) 651166 & (2) 651128 (For #655081)
4	(4) 651128 (For #655082)

- Mount heavier doors
 - 10 Series – 40 lb. capacity
 - 15 Series – 75 lb. capacity
- Hinges TSLOTS extrusions together
- Low profile mounts to T-Slot
- Clear anodize finish matches TSLOTS finish

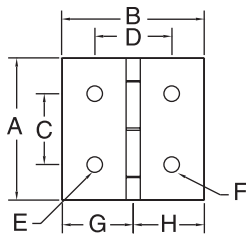

ITEM #	CAPACITY	A	B	C	D	E	F	G	H
655083	40 lbs	2.00	2.00	1.00	1.063	.257(4)	N/A	1.00	1.00
655081	75 lbs	3.00	2.50	1.50	1.375	.328(2)	.257(2)	1.50	1.00
655082	75 lbs	3.00	3.00	1.50	1.625	.328(4)	N/A	1.50	1.50

DOOR HANDLES



ITEM #	DESCRIPTION
655058	15 S Large Plastic Door Handle-Black 15S 40S
655059	15 S Medium Plastic Door Handle-Black 15S 40S
655060	10 S Small Plastic Door Handle-Black 10S 25S

RECOMMENDED BOLT ASSEMBLY

QTY	ITEM #
2	651234 (For Handle Item #655060)
2	651202 (For Handle Item #655059)
2	651202 (For Handle Item #655058)

- Mounts directly in T-Slot or machined panel
- Made of black nylon
- 10 and 15 Series sizes

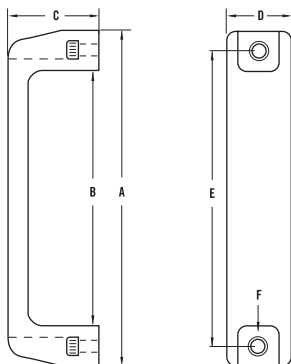

ITEM #	SERIES	A	B	C	D	E	F
655060	10 S	4.30	2.90	1.40	.82	3.60	1/4" SHCS (2)
655059	15 S	5.37	3.73	1.62	1.03	4.50	5/16" SHCS (2)
655058	15 S	7.81	5.93	2.00	1.18	6.97	5/16" SHCS (2)

OFFSET DOOR HANDLE 10S 15S



ITEM # 655076 DESCRIPTION Offset Door Handle

- Mounts directly in T-Slot or machined panel
- Matte glass filled nylon plastic, orange cover strip
- Fasteners Included – (2) 1/4-20 x 5/8" BHSCS BLACK
(2) 1/4-20 x 3/4" BHSCS BLACK
(2) Black Zinc 10 S Economy T-Nut
- 10 and 15 Series compatible

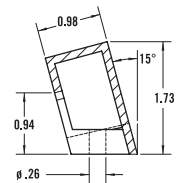
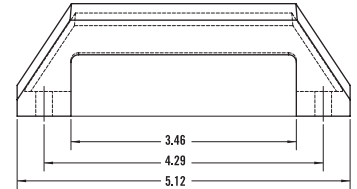

STEEL DOOR HANDLES 10S 15S 25S 40S



ITEM # 655068 DESCRIPTION Steel Door Handle

- Mounts directly to panel or door
- Fasteners included – (2) 8-32 x 1/2" BHSCS
- 10 and 15 Series compatible

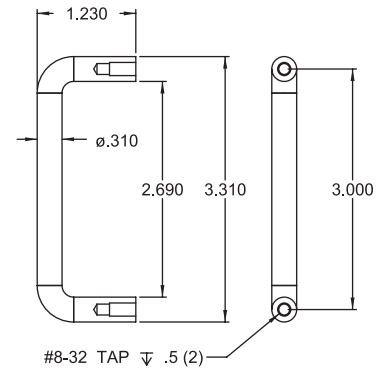

ALUMINUM DOOR HANDLES 15S



ITEM # 655562 DESCRIPTION 5" Natural Aluminum Door Handle

- Mounts directly in T-Slot or machined panel
- 15 Series compatible

RECOMMENDED FASTENERS

ITEM #	DESCRIPTION	QTY
651027	1/4-20 x 3/4" SHCS	2
651105	Black Zinc 15 S Economy T-Nut offset	2

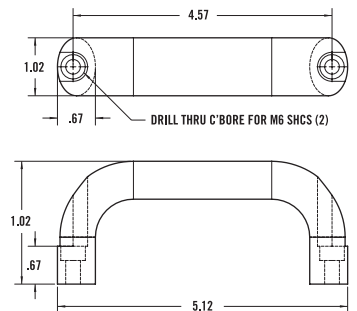

TSLOTS Hardware

SLAM LATCH 15S 40S



ITEM #	DESCRIPTION
655769	Slam Latch w/ Unique Key
664083	Slam Latch w/o Key

- Black powder coat
- 15S and 40S compatible
- Ideal for cabinets and guarding

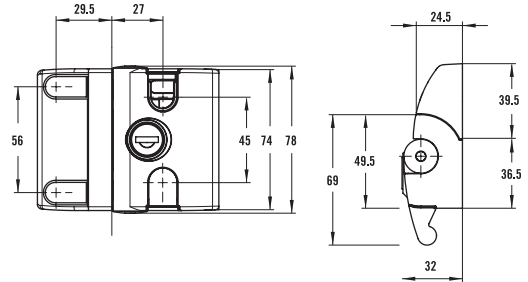

RECOMMENDED FASTENERS

ITEM #	DESCRIPTION	QTY
651334	M6 x 16mm SHCS	4/ea (per catch)
651366	Bright Zinc 15S / 40S Metric Economy T-Nut offset	4/ea (per catch)

DELUXE DOOR HANDLE 15S 40S



ITEM #	DESCRIPTION
655053	Non-Locking Door Latch
655061	Locking Door Latch w/Key

- Corrosion resistant chrome finish
- Available in locking or non-locking handle
- Ideal for cabinets and guarding
- Fasteners Included – (2) 10-32 x 1 1/2" FHSCS
- Door Latch Milling Machining Service required – item number 660086, page 11:08.

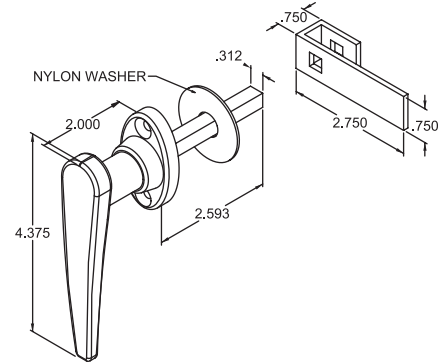

90° DEADBOLT LATCH 10S 15S 25S 40S



ITEM #	DESCRIPTION
655103	Deadbolt Latch With Side Latch

- Positive, spring loaded deadbolt
- Ideal for enclosure doors
- 10 and 15 Series compatible
- Fasteners included – 651022, 651075
- Stainless Steel bolt and spring

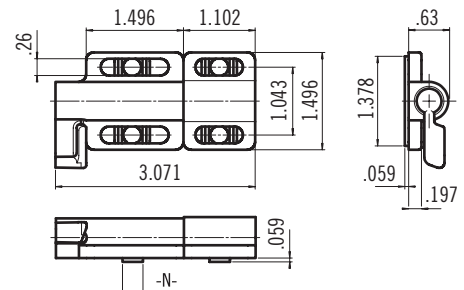

GRABBER™ DOOR CATCH 10S 15S 25S 40S



ITEM #	DESCRIPTION
655067	3 Lbs Pull Force Grabber Door Catch And Keeper
655085	5 Lbs Pull Force Grabber Door Catch And Keeper
655118	10 Lbs Pull Force Grabber Door Catch And Keeper

- Mounts inside your enclosure
- Push to close, pull to open
- Spring loaded over center action
- 3 pull-up forces to choose from
- Corrosion resistant black ABS
- 10 and 15 Series compatible
- Mounts to TSLOTS using Mounting Plates seen below.
- Fasteners included – (4) 6-32 BHSCS for mounting plates

Grabber™ Door Catch is a registered trademark of Southco, Inc.

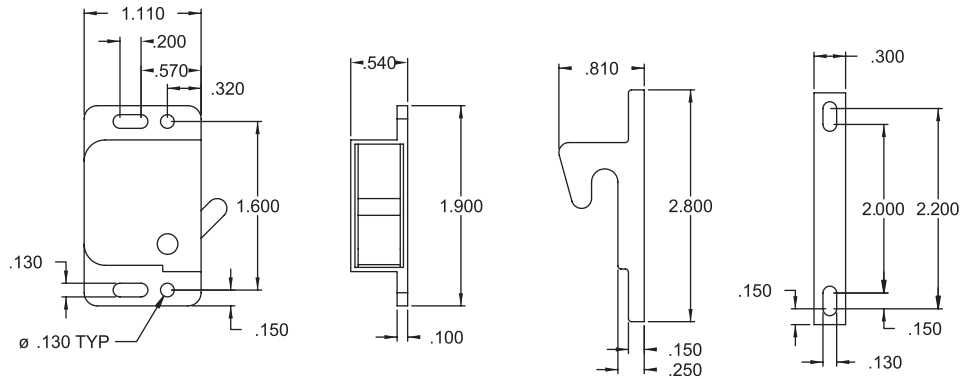

GRABBER™ DOOR CATCH MOUNTING PLATES 10S 15S 25S 40S



ITEM #	DESCRIPTION
655117	10 & 15 S Grabber™ Door Catch Mounting Plate

RECOMMENDED FASTENERS

ITEM #	SERIES	DESCRIPTION
651155	10 S	Economy T-Nut Kit
651156	10 S	Drop In T-Nut Kit
651224	15 S	Drop In T-Nut Kit
651130	15 S	Economy T-Nut Kit

- Mounts Grabber™ Door Catch to TSLOTS
- Made from 1/4" clear anodized aluminum
- 10 and 15 Series Compatible

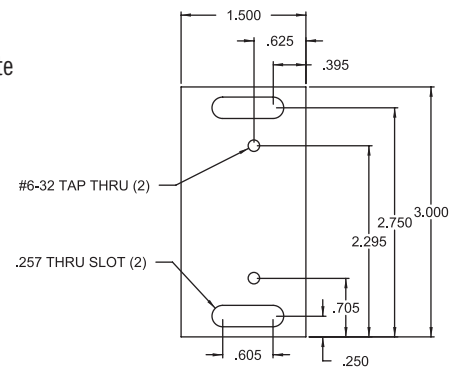

TSLOTS Hardware

MAGNETIC DOOR CATCH 10S 15S 25S 40S



ITEM # 655087 DESCRIPTION Magnetic Door Catch

- Ideal for latching panels in place
- 10 and 15 Series compatible
- Use with all TSLOTS extrusions
- Fasteners included
- To mount to extrusion, use either Magnetic Door Catch Bracket on page 06:09 - for 0° or 90° connection.

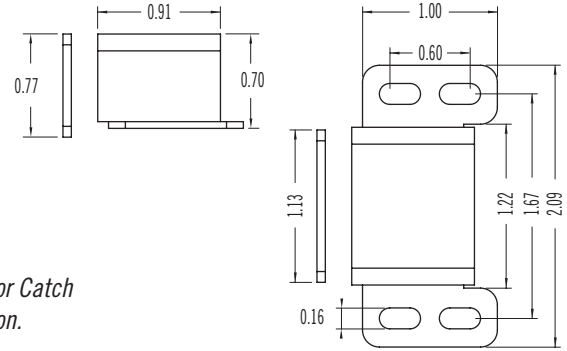

MAGNETIC DOOR CATCH BRACKET 10S 15S 25S 40S



ITEM # 655471 DESCRIPTION Magnetic Door Catch Bracket

- Ideal for catching a framed-in extrusion door
- Use with Magnetic Door Catch
- 10 and 15 Series compatible
- Fasteners included – (2) 651080, (2) 651022, (2) 651163

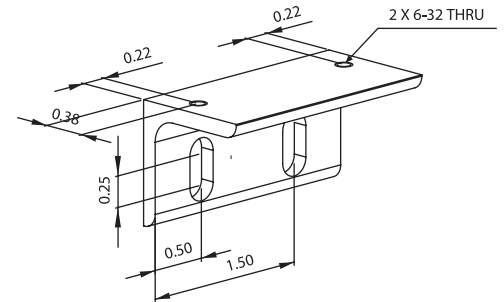

DOUBLE BALL CATCH 10S 15S 25S 40S



ITEM # 657169 DESCRIPTION Double Ball Catch
699769 Double Ball Catch Mounting Bracket, Screws and T-nuts Kit

- Brass - chrome plated
- All fasteners included with 699769

TOP MOUNT BIFOLD DOOR HANGER ASSEMBLY



ITEM #	DESCRIPTION
655057	10 S Top Mount Bifold Door Hanger  
655050	15 S Top Mount Bifold Door Hanger  

- Allows you to make a sliding or bifold door without using a bottom sliding rail.
- 10 and 15 Series compatible
- Fastens to extrusion end
- Rotates freely as door pivots
- Made from UHMW polyethelene

TOP MOUNT BIFOLD DOOR HANGER PROFILE











ITEM #	DESCRIPTION
657054	10 S Bifold Door Hanger Profile  
657087	15 S Bifold Door Hanger Profile  

- Allows you to make your own door hangers
- 10 and 15 Series compatible
- 120" stock length

DOOR SLIDE TRACK



ITEM #	DESCRIPTION
655189	10 S Upper Door Slide Track  
655191	10 S Lower Door Slide Track  
655188	15 S Upper Door Slide Track  
655190	15 S Lower Door Slide Track  

- Snaps into T-Slot
- Deeper slot in upper track allows panel to be inserted after frame is assembled
- Radius bearing surface in lower track allows for easier sliding
- 10 and 15 Series sizes
- 145" stocked length

» See page 11:05 for miscellaneous cut charge.

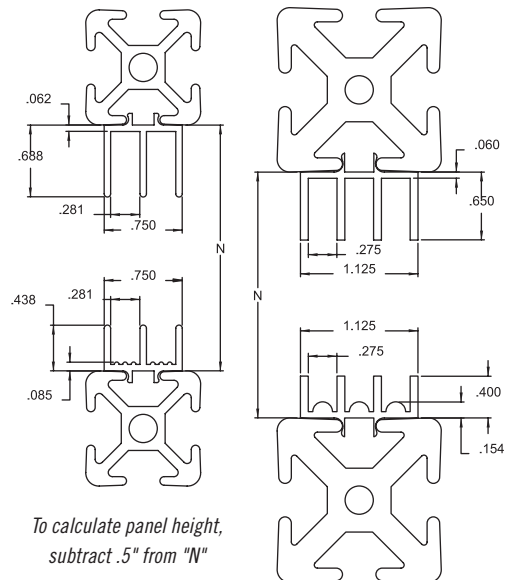

TSLOTS Hardware

PANEL STIFFENER

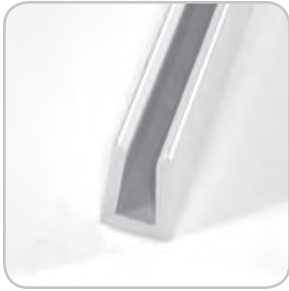

ITEM #	LENGTH	DESCRIPTION
655285	72"	Aluminum Panel Stiffener

◦ Increases the rigidity of 1/4" panels

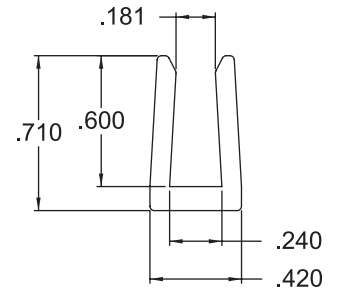

RUBBER PANEL GASKET 10S 15S



SOLD BY THE FOOT

ITEM #	DESCRIPTION	LENGTH
655111	10 S Rubber Panel Gasket 10S	1'
655110	15 S Rubber Panel Gasket 15S	1'

SOLD BY THE ROLL

ITEM #	DESCRIPTION	LENGTH
655113	10 S Rubber Panel Gasket 10S	150' Roll
655112	15 S Rubber Panel Gasket 15S	150" Roll

06:12

ECONOMY PLASTIC PANEL GASKET

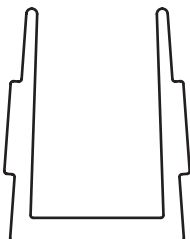

ITEM #	DESCRIPTION
655639	10 S Economy Plastic Panel Gasket 10S 25S

◦ Stocked in 96" lengths
 ◦ 10 S economy gasket will accommodate 3/16" panels

DELUXE PLASTIC PANEL GASKET



ITEM #	DESCRIPTION
655640	10 S Deluxe Plastic Panel Gasket 8' 10S 25S
655827	15 S Deluxe Plastic Panel Gasket 72" - Black 15S 40S
655760	15 S Deluxe Plastic Panel Gasket 2M- Yellow 15S 40S
655761	15 S Deluxe Plastic Panel Gasket 2M- Natural 15S 40S

- 10 S and 15 S Sizes
- The deluxe gasket can also be used as a T-Slot cover
- 15 S deluxe gasket will accommodate 3/16" and 1/4" panels
- 10 S deluxe gasket will accommodate 1/8" and 3/16" panels
- Made of HDPE
- Stocked in 96" lengths
- Black stocked in 72" lengths
- Yellow & Natural stocked in 2 M lengths

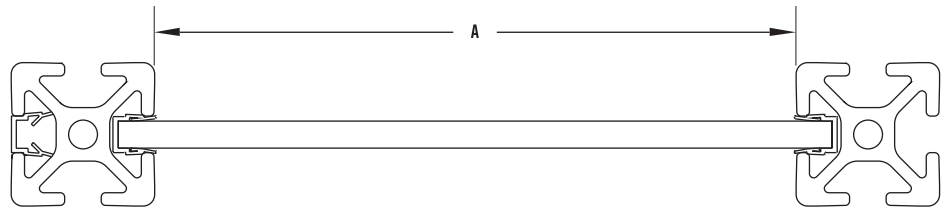
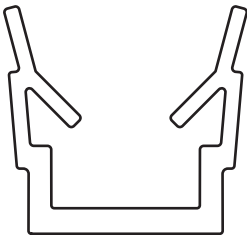

15 SERIES / 40 SERIES
TO CALCULATE PANEL HEIGHT,
ADD .75" TO "A"

10 SERIES / 25 SERIES
TO CALCULATE PANEL HEIGHT,
ADD .50" TO "A"

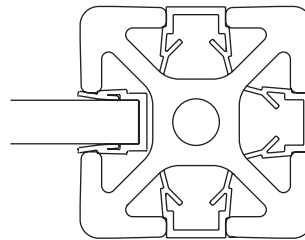

TSLOTS Hardware

PANEL MOUNT BLOCK

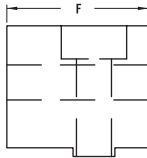
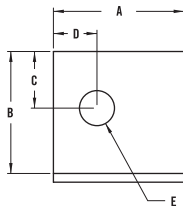

ITEM #	DESCRIPTION
655286	15 S Panel Mount Block 15S 40S
655288	10 S Panel Mount Block 10S 25S

655288 mounts 3/16" panels flush with 10 Series extrusions
 655286 mounts 1/4" panels flush with 15 Series extrusions

- Allows you to mount panel flush or offset with extrusion
- Simplifies adding or removing panels
- Drilling panel required
- Fasteners for mounting to extrusion included

ITEM #	A	B	C	D	E	F
655288	0.75	0.7	0.325	0.25	1/4-20 TAP THRU	0.812
655286	1	0.88	0.44	0.39	5/16-18 TAP THRU	1.25

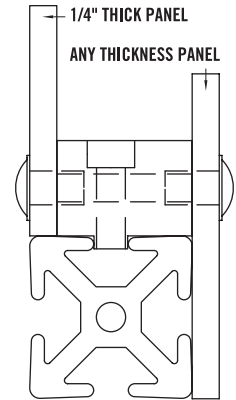

NYLON PANEL MOUNT BLOCK



ITEM #	DESCRIPTION
655681	15 Series Nylon Panel Mount Block 15S 40S

- 15 Series Compatible
- Panel inserts from the top then twists 90° to lock into place.
- Includes 1/4-20 x 1" Mounting Screw
- Includes 2 Shims, One to mount a 1/4" panel flush to the extrusion and one to mount the 1/4" panel on the outside of the extrusion.
- Made of Black Nylon
- .5" offset from edge for hole placement of panel.

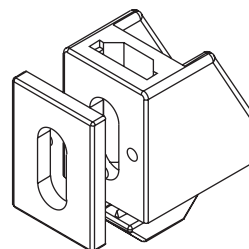
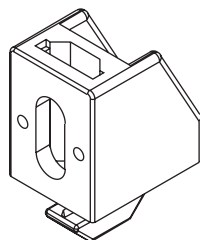

PANEL MOUNT BRACKET



ITEM #	DESCRIPTION
655289	10 S Panel Mount Bracket 10S 25S
655291	15 S Panel Mount Bracket 15S 40S

RECOMMENDED FASTENERS FOR EXTRUSION

QTY	ITEM #
1	651166 (For Bracket Number #655289)
1	651128 (For Bracket Number #655291)

RECOMMENDED FASTENERS FOR 1/4" PANEL

QTY	ITEM #
1	651002 (For Bracket Number #655289)
1	651210 (For Bracket Number #655291)

- Lower cost alternative than Panel Mount Block
- Mounts 1/4" panel flush with 15 Series extrusion
- Slotted hole makes alignment easy
- Drilling panel required
- 10 and 15 Series sizes

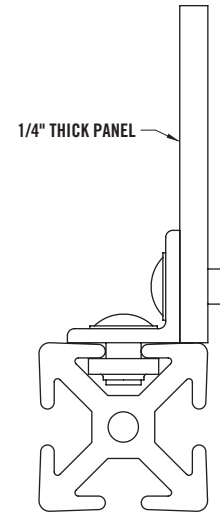

ITEM #	A	B	C	D	E	F	G	H	J
655289	1.00	1.00	0.25	0.5	0.5	1.00	0.257	0.129	0.125
655291	1.00	1.00	0.25	0.5	0.5	1.00	0.328	0.164	0.125

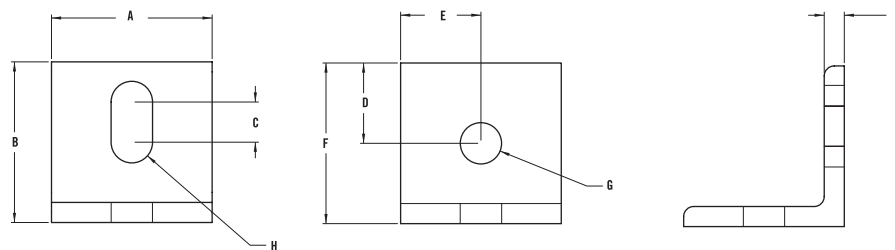

CUP HOLDER 10S 15S 25S 40S



ITEM #	DESCRIPTION
655763	Open Bottom

- Black Nylon

TSLOTS Hardware

PANEL RETAINER



ITEM #	DESCRIPTION
655329	10 S 1" Panel Retainer 10S 25S
655330	10 S 2" Panel Retainer 10S 25S
655295	15 S 1.5" Single Panel Retainer 15S
655294	15 S 3" Single Panel Retainer 15S
664039	40 S Single Panel Retainer 40S

RECOMMENDED FASTENERS FOR EXTRUSION

QTY	ITEM #
1	651130 (For Bracket Number #655329)
1	651129 (For Bracket Number #655295)
2	651130 (For Bracket Number #655330)
2	651129 (For Bracket Number #655294)

RECOMMENDED FASTENERS FOR 1/4" PANEL

QTY	ITEM #
1	651169 (For Bracket Number #655329)
1	651135 (For Bracket Number #655295)
2	651169 (For Bracket Number #655330)
2	651135 (For Bracket Number #655294)

- Strongest way to retain panels
- Simplifies panel installation and removal
- Drilling panel required
- 10 and 15 Series sizes

	655329	655295	655330	655294
A	0.188	0.25	0.188	0.25
B	0.563	0.84	0.563	0.84
C	1	1.5	1	1.5
D	0.938	1.379	0.938	1.379
E	1.938	2.879	1.938	2.879
F	0.5	0.75		
G	1	1.5		
H			0.5	0.75
J			1	1.5
K			2	3.00
L	0.392	0.594	0.392	0.594
M	1.108	1.656	1.108	1.656
N	1/4-20	5/16-18	1/4-20	5/16-18
P	0.257	0.328	0.257	0.328
U	0.375	0.59	0.375	0.59

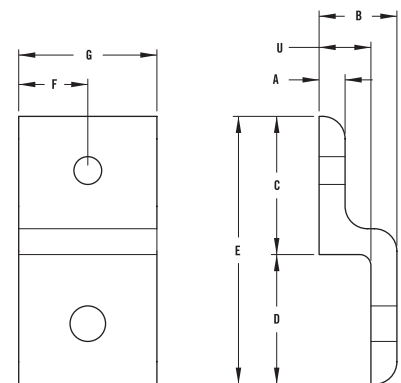
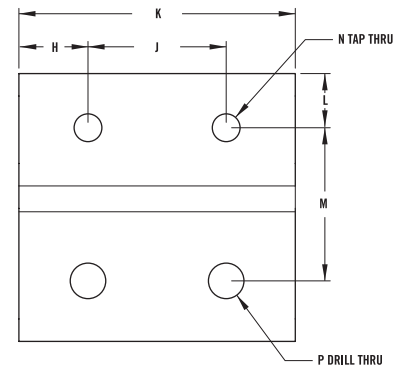

DOUBLE PANEL RETAINER



ITEM #	DESCRIPTION
655343	1" Double Panel Retainer 10S 25S
655344	2" Double Panel Retainer 10S 25S
655345	1.5" Double Panel Retainer 15S
655346	3" Double Panel Retainer 15S

RECOMMENDED FASTENERS FOR EXTRUSION

QTY	ITEM #
1	651130 (For 655343)
2	651130 (For 655344)
1	651129 (For 655345)
2	651129 (For 655346)

RECOMMENDED FASTENERS FOR 1/4" PANEL

QTY	ITEM #
2	651169 (For 655343)
4	651169 (For 655344)
2	651135 (For 655345)
4	651135 (For 655346)

- Strongest way to retain panels
- Simplifies panel installation and removal

	655343	655344	655345	655346
A	0.188	0.188	0.250	0.250
B	0.563	0.563	0.840	0.840
C	1.000	1.000	1.500	1.500
D	1.021	1.021	1.523	1.523
E	3.021	3.021	4.523	4.523
F	0.375	0.375	0.590	0.590
G	1.000	2.000	1.500	3.000
H	0.500	0.500	0.750	0.750
J		1.000		1.500
K	0.392	0.392	0.594	0.594
L	1.118	1.118	1.666	1.666
M	2.237	2.237	3.335	3.335
N	1/4-20	1/4-20	5/16-18	5/16-18
P	0.257	0.257	0.328	0.328

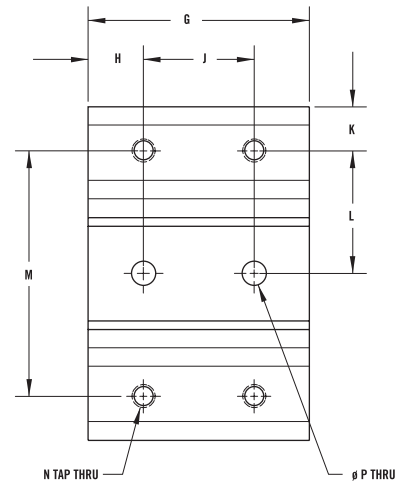
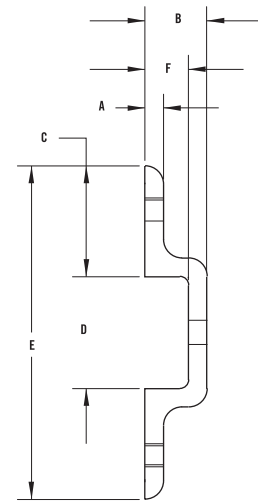

TSLOTS Hardware

MESH PANEL RETAINER



- Strongest way to retain wire mesh
- Prevents wire mesh from pushing out of T-Slot
- Simplifies installation and removal of wire mesh
- 10 and 15 Series sizes

*Fasteners for gauge wire included.

ITEM #	DESCRIPTION
655323	1" Mesh Retainer (10S) (25S)
655293	1.5" Single Mesh Retainer (15S)
655326	2" Mesh Retainer (10S) (25S)
655292	3" Single Mesh Retainer (15S)
655324	1" Mesh Retainer w/ Backing Plate* (10S) (25S)
655299	1.5" Backing Plate (15S)
655297	1.5" Single Mesh Retainer w/ Backing Plate* (15S)
655327	2" Mesh Retainer w/ Backing Plate* (10S) (25S)
655296	3" Single Mesh Retainer w/ Double Backing Plate* (15S)
655325	1" Backing Plate (10S) (25S)
655299	Backing Plate For 1.5" Mesh Retainer (15S)
655328	2" Backing Plate (10S) (25S)
655298	3" Double Backing Plate (15S)
664066	40 S Single Mesh Retainer w/ Backing Plate (40S)

RECOMMENDED FASTENERS FOR EXTRUSION

QTY	ITEM #
1	651130 (For Retainer Number #655324) & 655323
1	651129 (For Retainer Number #655297) & 655293
2	651130 (For Retainer Number #655327) & 655326
2	651129 (For Retainer Number #655296) & 655292

RECOMMENDED FASTENERS FOR GAUGE WIRE

QTY	ITEM #
1	651023 (For Retainer Number #655323)
1	651053 (For Retainer Number #655293)
2	651023 (For Retainer Number #655326)
2	651053 (For Retainer Number #655292)

	655324	655297	655327	655296
A	0.188	0.25	0.188	0.25
B	0.563	0.84	0.563	0.84
C	1	1.5	1	1.5
D	0.938	1.379	0.938	1.379
E	1.938	2.879	1.938	2.879
F	0.5	0.75		
G	1	1.5		
H			0.5	0.75
J			1	1.5
K			2	3
L	0.25	0.344	0.25	0.344
M	0.875	1.406	0.875	1.406
N	1/4-20	5/16-18	1/4-20	5/16-18
P	0.375	0.5	0.375	0.5
S	1	1.5	1	1.5
T	0.255	0.328	0.255	0.328
U	0.375	0.59	0.375	0.59
V	0.5	0.75	0.5	0.75

MESH RETAINER DETAIL

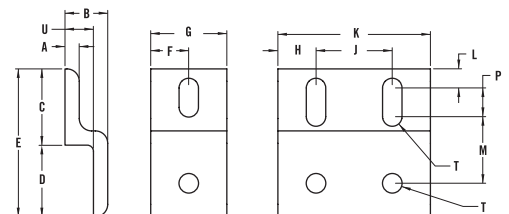

BACKING PLATE DETAIL

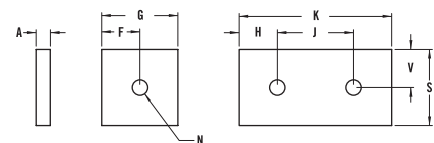

DOUBLE MESH PANEL RETAINER



- Prevents panels from pushing out
- Simplifies installation and removal

ITEM #	DESCRIPTION
655351	1" Double Mesh Retainer 10S 25S
655353	2" Double Mesh Retainer 10S 25S
655347	1.5" Double Mesh Retainer 15S
655349	3" Double Mesh Retainer 15S
655352	1" Double Mesh Retainer with Backing Plates * 10S 25S
655354	2" Double Mesh Retainer with Double Backing Plates * 10S 25S
655348	1.5" Double Mesh Retainer with Backing Plates * 15S
655350	3" Double Mesh Retainer with Double Backing Plates * 15S
655325	1" Backing Plate 10S 25S
655328	2" Double Backing Plate 10S 25S
655299	1.5" Backing Plate 15S
655298	3" Double Backing Plate 15S

**Fasteners for gauge wire included.*

RECOMMENDED FASTENERS FOR EXTRUSION

QTY	ITEM #
1	651130 (For 655351 & 655352)
2	651130 (For 655353 & 655354)
1	651129 (For 655347 & 655348)
2	651129 (For 655349 & 655350)

RECOMMENDED FASTENERS FOR GAUGE WIRE

QTY	ITEM #
2	651023 (For 655351) 10S
4	651023 (For 655353) 10S
2	651053 (For 655347) 15S
4	651053 (For 655349) 15S

	655351	655353	655347	655349
A	0.188	0.188	0.250	0.250
B	0.563	0.563	0.840	0.840
C	1.000	1.000	1.500	1.500
D	1.021	1.021	1.523	1.523
E	3.021	3.021	4.523	4.523
F	0.375	0.375	0.590	0.590
G	1.000	2.000	1.500	3.000
H	0.500	0.500	0.750	0.750
J		1.000		1.500
K	0.250	0.250	0.344	0.344
L	0.375	0.375	0.500	0.500
M	1.230	1.230	1.916	1.916
N	1/4-20	1/4-20	5/16-18	5/16-18
P	0.257	0.257	0.328	0.328
T	0.128	0.128	0.164	0.164

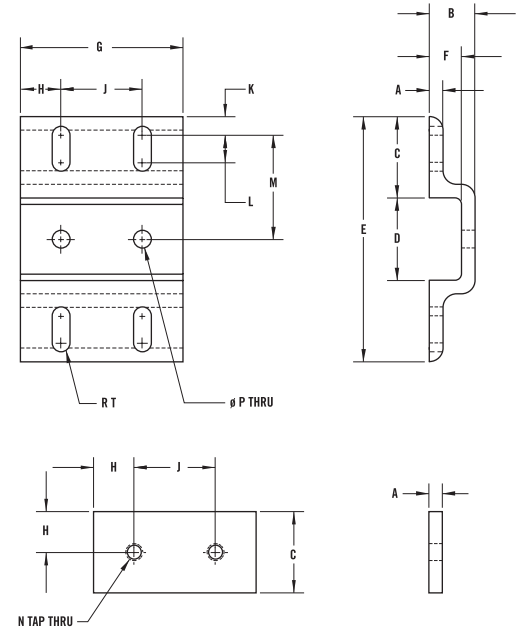

TSLOTS Hardware

PLASTIC PANELS 10S 15S 25S 40S

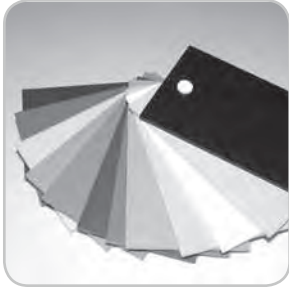

» See page 11:13 for machining services.
 » See page 06:22 for area calculation matrix.

ITEM #	DESCRIPTION	THICKNESS	SHEET SIZE
655424	1/4" Clear Acrylic	0.236	4' x 8'
655425	3/16" Clear Acrylic	0.177	4' x 8'
655426	1/4" White Acrylic	0.236	4' x 8'
655427	3/16" White Acrylic	0.177	4' x 8'
655428	1/4" Black Acrylic	0.236	4' x 8'
655429	3/16" Black Acrylic	0.177	4' x 8'
655432	1/4" Clear Polycarbonate	0.236	4' x 8'
655433	3/16" Clear Polycarbonate	0.177	4' x 8'
655448	1/4" Gray Polycarbonate	0.236	4' x 8'
655449	3/16" Gray Polycarbonate	0.177	4' x 8'
655690	6mm Black HDPE	0.236	4' x 8'
655436	1/4" Black Haircell ABS	0.236	4' x 8'
655437	3/16" Black Haircell ABS	0.177	4' x 8'
655440	6mm Black Expanded PVC	6mm	4' x 8'
655441	3mm Black Expanded PVC	3mm	4' x 8'
655442	6mm Red Expanded PVC	6mm	4' x 8'
655443	3mm Red Expanded PVC	3mm	4' x 8'

- Use for guarding, enclosures, shelving, cabinets, etc.
- Machining Service – Panel Cut to Size 660062 & 660063
- Panels are ordered by the sq. ft.
- All panels can be used in 10, 15, 25 and 40 Series slots

06:20

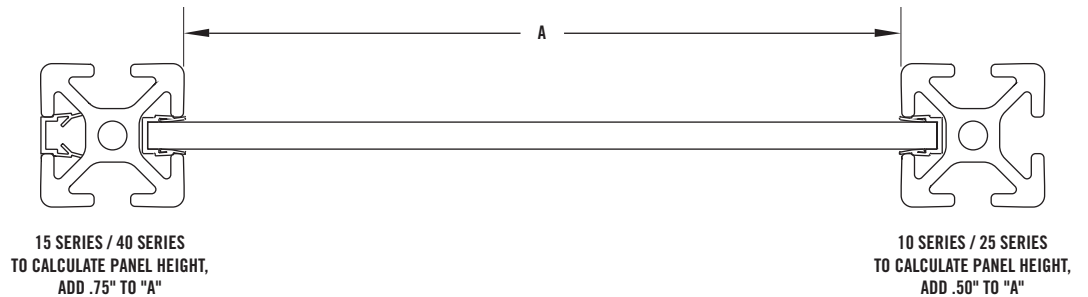

ALUCOBOND® PANELS 10S 15S 25S 40S

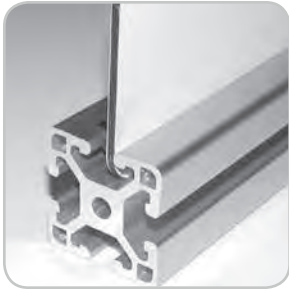

ITEM #	DESCRIPTION
655457	Alucobond 4mm Panel - Platinum

- Silver painted .020" thick aluminum sheets separated by a thermoplastic core
- Painted only on one side
- Lower cost alternative than a 1/4" thick aluminum panel
- Machining Service - Panel Cut to Size 660062 & 660063
- Stock panel size 48" x 120"

» See page 11:13 for cut to size services.
 » See page 06:22 for area calculation matrix.

ALUMALITE® PANELS 10S 15S 25S 40S

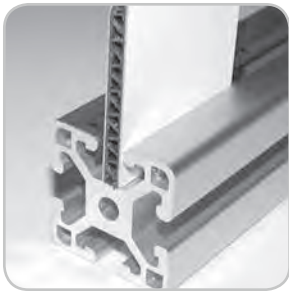

ITEM #	DESCRIPTION	SIZE
655452	6mm Alupalite Panel - Blue	4' x 8'
655454	6mm Alupalite Panel - Silver	4' x 8'

- Super lightweight
- Ideal for low impact enclosures
- Stock panel size 48" x 96"

» See page 11:13 for cut to size services.
 » See page 06:22 for area calculation matrix.

PVC COATED WIRE MESH 10S 15S 25S 40S

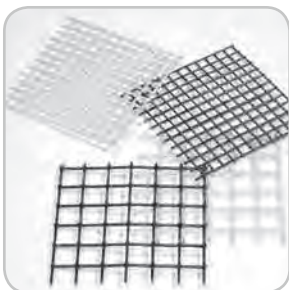

ITEM #	DESCRIPTION	WIRE GAUGE	THICKNESS
655318	1/2" x 1/2" Black PVC Coated Wire Mesh	16	.14"
655319	1/2" x 1/2" Yellow PVC Coated Wire Mesh	16	.14"
655316	1" x 1" Black PVC Coated Wire Mesh	12	.21"
655317	1" x 1" Yellow PVC Coated Wire Mesh	12	.21"

- Stocked in 4' x 8' sheets
- Cutting available - see page 11:10
- Use calculation matrix on page 06:22 to measure area
- Machining service - panel cut to size 660060 & 660061

TSLOTS Hardware

AREA CALCULATION MATRIX

HOW TO USE THE MATRIX

- Round both length and width dimensions up to the next 6" increment
- Find the length and width along the top and side of area calculation matrix
- Find the area in square feet at the intersection of the length and width matrix

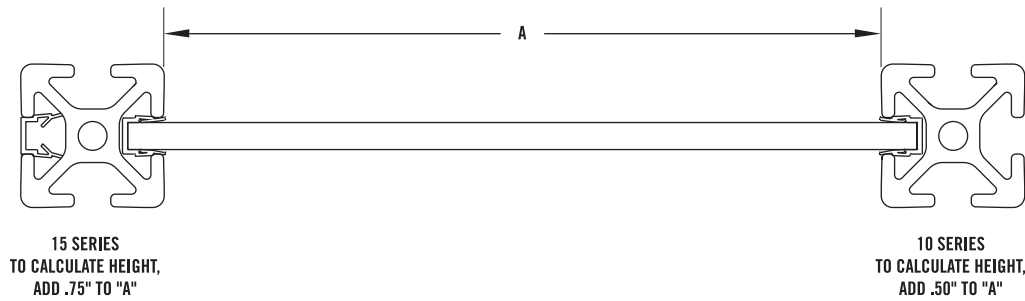

		WIDTH									
		6"	12"	18"	24"	30"	36"	42"	48"	54"	60"
LENGTH	6"	0.25	0.50	0.75	1.00	1.25	1.50	1.75	2.00	2.25	2.50
	12"	0.50	1.00	1.50	2.00	2.50	3.00	3.50	4.00	4.50	5.00
	18"	0.75	1.50	2.25	3.00	3.75	4.50	5.25	6.00	6.75	7.50
	24"	1.00	2.00	3.00	4.00	5.00	6.00	7.00	8.00	9.00	10.00
	30"	1.25	2.50	3.75	5.00	6.25	7.50	8.75	10.00	11.25	12.50
	36"	1.50	3.00	4.50	6.00	7.50	9.00	10.50	12.00	13.50	15.00
	42"	1.75	3.50	5.25	7.00	8.75	10.50	12.25	14.00	15.75	17.50
	48"	2.00	4.00	6.00	8.00	10.00	12.00	14.00	16.00	18.00	20.00
	54"	2.25	4.50	6.75	9.00	11.25	13.50	15.75	18.00	20.25	22.50
	60"	2.50	5.00	7.50	10.00	12.50	15.00	17.50	20.00	22.50	25.00
	66"	2.75	5.50	8.25	11.00	13.75	16.50	19.25	22.00	24.75	27.50
	72"	3.00	6.00	9.00	12.00	15.00	18.00	21.00	24.00	27.00	30.00
	78"	3.25	6.50	9.75	13.00	16.25	19.50	22.75	26.00	29.25	32.50
	84"	3.50	7.00	10.50	14.00	17.50	21.00	24.50	28.00	31.50	35.00
	90"	3.75	7.50	11.25	15.00	18.75	22.50	26.25	30.00	33.75	37.50
	96"	4.00	8.00	12.00	16.00	20.00	24.00	28.00	32.00	36.00	40.00
	102"	4.25	8.50	12.75	17.00	21.25	25.50	29.75	34.00	38.25	42.50
108"	4.50	9.00	13.50	18.00	22.50	27.00	31.50	36.00	40.50	45.00	

06:22

SLATWALL PANELS



ITEM #	DESCRIPTION
599900	12'6" Slatwall Panel
301901	12' Channel 3/4" x 1/2"

RECOMMENDED FASTENERS FOR 10 S TSLOTS

QTY	ITEM #	DESCRIPTION
1	653273	10 to 15 S - 2 Hole Transition Strip
1	651130	1/4-20 x 1/2" FBHSCS & Economy T-Nut
1	651129	5/16-18 x 11/16" FBHSCS & Economy T-Nut

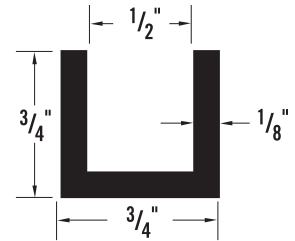

RECOMMENDED FASTENERS FOR 15 S TSLOTS

QTY	ITEM #	DESCRIPTION
1	653141	15 S 2 Hole Joining Strip
2	651129	5/16-18 x 11/16" FBHSCS & Economy T-Nut

CALCULATION FORMULA FOR NUMBER OF PANELS NEEDED





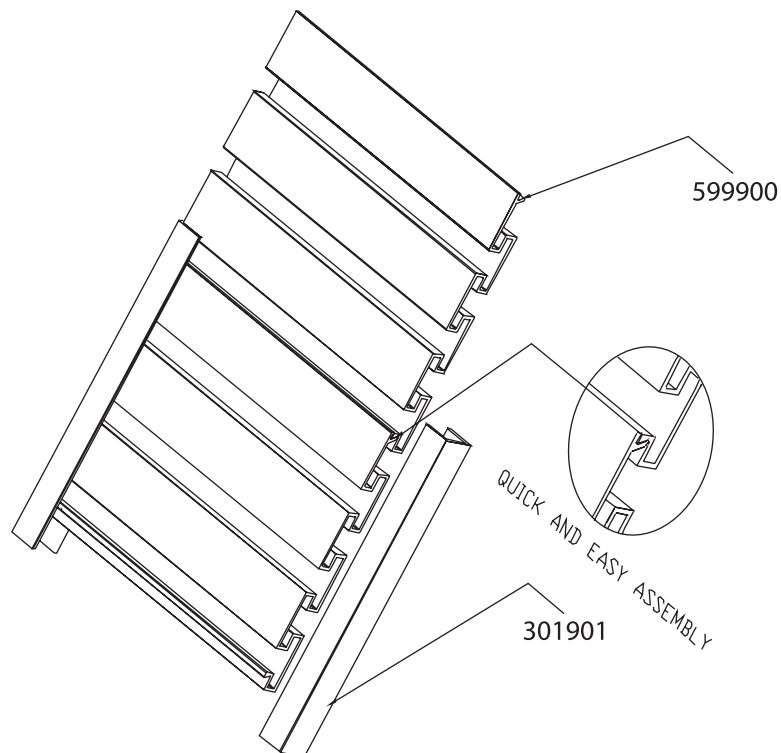
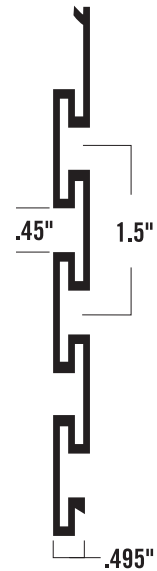



























$$\frac{(\text{Desired Panel Height} - 0.335)}{4.6}$$

- » Custom size panels are available.
- » Round to the next full panel.



TSLOTS Hardware

45° SUPPORT

ITEM #	DESCRIPTION	INCLUDED HARDWARE	QTY
655371	1010 x 6" 45° Support  	1/4-20 x 5/8" SHCS, Washer & Economy T-Nut	2
655375	1010 x 12" 45° Support  	1/4-20 x 5/8" SHCS, Washer & Economy T-Nut	2
655380	1010 x 18" 45° Support  	1/4-20 x 5/8" SHCS, Washer & Economy T-Nut	2
655372	1020 x 6" 45° Support  	1/4-20 x 5/8" SHCS, Washer & Economy T-Nut	4
655373	1020 x 12" 45° Support  	1/4-20 x 5/8" SHCS, Washer & Economy T-Nut	4
655374	1020 x 18" 45° Support  	1/4-20 x 5/8" SHCS, Washer & Economy T-Nut	4
655355	1515 x 6" 45° Support 	5/16-18 x 3/4" SHCS, Washer & Economy T-Nut	2
655359	1515 x 12" 45° Support 	5/16-18 x 3/4" SHCS, Washer & Economy T-Nut	2
655363	1515 x 18" 45° Support 	5/16-18 x 3/4" SHCS, Washer & Economy T-Nut	2
655365	1515 x 24" 45° Support 	5/16-18 x 3/4" SHCS, Washer & Economy T-Nut	2
655367	1515-Lite x 12" 45° Support 	5/16-18 x 3/4" SHCS, Washer & Economy T-Nut	2
655368	1515-Lite x 6" 45° Support 	5/16-18 x 3/4" SHCS, Washer & Economy T-Nut	2
655369	1515-Lite x 18" 45° Support 	5/16-18 x 3/4" SHCS, Washer & Economy T-Nut	2
655370	1515-Lite x 24" 45° Support 	5/16-18 x 3/4" SHCS, Washer & Economy T-Nut	2
655357	1530 x 6" 45° Support 	5/16-18 x 3/4" SHCS, Washer & Economy T-Nut	4
655361	1530 x 12" 45° Support 	5/16-18 x 3/4" SHCS, Washer & Economy T-Nut	4
655364	1530 x 18" 45° Support 	5/16-18 x 3/4" SHCS, Washer & Economy T-Nut	4
655366	1530 x 24" 45° Support 	5/16-18 x 3/4" SHCS, Washer & Economy T-Nut	4
655381	1530-Lite x 6" 45° Support 	5/16-18 x 3/4" SHCS, Washer & Economy T-Nut	4
655382	1530-Lite x 12" 45° Support 	5/16-18 x 3/4" SHCS, Washer & Economy T-Nut	4
655383	1530-Lite x 18" 45° Support 	5/16-18 x 3/4" SHCS, Washer & Economy T-Nut	4
655384	1530-Lite x 24" 45° Support 	5/16-18 x 3/4" SHCS, Washer & Economy T-Nut	4
655356	1545 x 6" 45° Support 	5/16-18 x 3/4" SHCS, Washer & Economy T-Nut	6
655358	1545 x 12" 45° Support 	5/16-18 x 3/4" SHCS, Washer & Economy T-Nut	6
655360	1545 x 18" 45° Support 	5/16-18 x 3/4" SHCS, Washer & Economy T-Nut	6
655362	1545 x 24" 45° Support 	5/16-18 x 3/4" SHCS, Washer & Economy T-Nut	6

» All 45 degree supports have hardware already attached and come as an assembly.

- Create 45° supports without external joining plates or connectors.
- Custom lengths to your specifications.

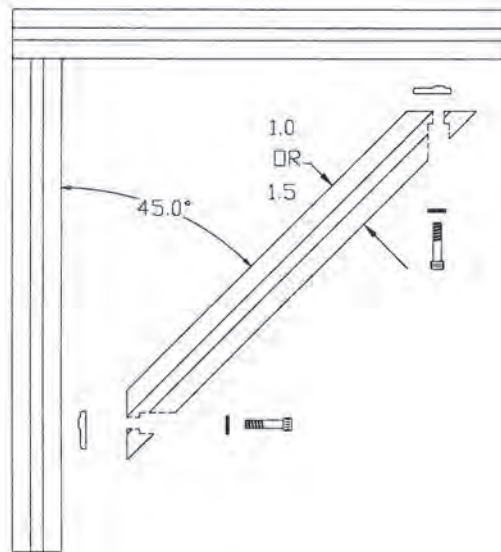
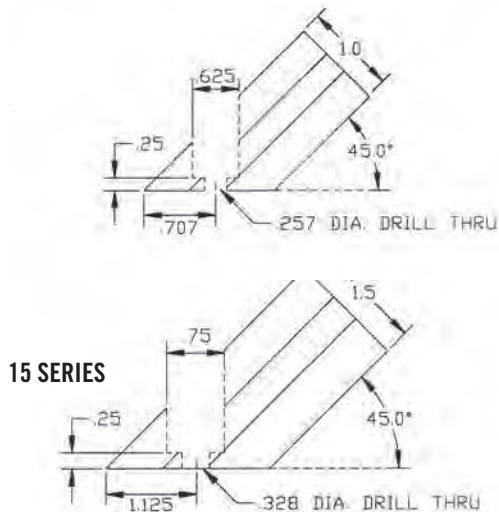

END CAPS



ITEM #	DESCRIPTION
655000	1" x 1" End Cap Black (10S) (25S)
655005	1" x 1" QR End Cap Black (10S) (25S)
655010	1" x 2" End Cap Black (10S) (25S)
655015	1" x 3" End Cap (10S) (25S)
655020	2" x 2" End Cap Black (10S) (25S)
655025	1.5" x 1.5" / 1.5" x 1.5" Lite End Cap Black (15S)
655030	1.5" x 1.5" QR End Cap Black (15S)
655035	1.5" x 3" / 1.5" x 3" Lite End Cap Black (15S)
655040	1.5" x 4.5" End Cap Black (15S)
655045	3" x 3" End Cap Black (15S)

- Allows you to cap off extrusion ends
- Push in fasteners included
- Can be mounted with 1/4-20 or 5/16-18 fasteners
- 10 and 15 Series sizes

» See page 04:09 for extra push in fasteners.

TSLOT COVERS

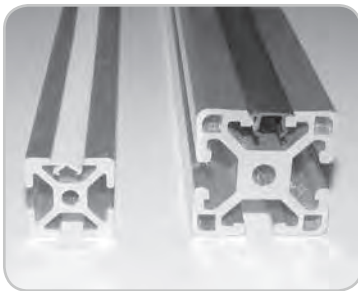

10 & 15 SERIES ECONOMY

ITEM #	DESCRIPTION
655105	15 S Black T-Slot Cover (15S) (40S)
655106	15 S Gray T-Slot Cover (15S) (40S)

- Stocked in 8' lengths

ITEM #	DESCRIPTION
655520	10 S Yellow T-Slot Cover (10S)
655521	10 S Black T-Slot Cover (10S)
655522	10 S Gray T-Slot Cover (10S)
655523	15 S Yellow T-Slot Cover (15S) (40S)
655524	15 S Black T-Slot Cover (15S) (40S)
655525	15 S Gray T-Slot Cover (15S) (40S)

- Stocked in 6' lengths
- Covers T-Slot to keep dust and dirt out
- Covers wires and tubes in T-Slot



15 SERIES DELUXE

TSLOTS Hardware

TSLOT COVER PROFILE



ITEM #	DESCRIPTION
655762	15 S NBR - Black  

◦ Can be used as an anti-slip stair tread

LAMINATED TABLE TOPS



ITEM #	DESCRIPTION
655509	30" x 48" x 1.25" Laminated Table Top – Gray
655510	30" x 48" x 1.25" Laminated Table Top – Almond
655511	30" x 60" x 1.25" Laminated Table Top – Gray
655512	30" x 60" x 1.25" Laminated Table Top – Almond
655513	30" x 72" x 1.25" Laminated Table Top – Gray
655514	30" x 72" x 1.25" Laminated Table Top – Almond
655515	36" x 72" x 1.25" Laminated Table Top – Gray
655516	36" x 72" x 1.25" Laminated Table Top - Almond

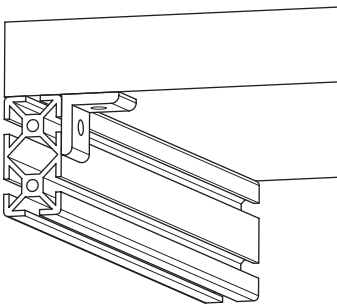

RECOMMENDED FASTENERS FOR 10 SERIES EXTRUSION

QTY	ITEM #	DESCRIPTION
1	655635	10 S Table Mount Assembly

RECOMMENDED FASTENERS FOR 15 SERIES EXTRUSION

QTY	ITEM #	DESCRIPTION
1	655636	15 S Table Mount Assembly

◦ 1.25" thick high-pressure laminate table top

◦ Comes in gray or almond

» Custom sizes and colors available upon request.

06:26

TUBE AND WIRE CLAMP 10S 15S 25S 40S



ITEM #	DESCRIPTION
655331	1/8" Single Tube Clamp
655332	1/4" Single Tube Clamp
655333	3/8" Single Tube Clamp
655334	1/2" Single Tube Clamp
655335	3/4" Single Tube Clamp
655336	1" Single Tube Clamp
655337	1/8" Double Tube Clamp
655338	1/4" Double Tube Clamp
655339	3/8" Double Tube Clamp
655340	1/2" Double Tube Clamp
655341	3/4" Double Tube Clamp
655342	1" Double Tube Clamp

RECOMMENDED FASTENERS

SINGLE CLAMP	655331	655332	655333	655334	655335	655336
DOUBLE CLAMP	655337	655338	655339	655340	655341	655342
10 SERIES	651117	651117	651118	651120	651121	651121
15 SERIES	651117	651118	651119	651120	651121	651121

FASTENER SIZE

10 SERIES	15 SERIES	DESCRIPTION
1/4-20x3/4"	1/4-20x3/4"	1/8" Tube and Wire Clamp
1/4-20x3/4"	1/4-20x7/8"	1/4" Tube and Wire Clamp
1/4-20x7/8"	1/4-20x1"	3/8" Tube and Wire Clamp
1/4-20x1 1/4"	1/4-20x1 1/4"	1/2" Tube and Wire Clamp
1/4-20x1 1/2"	1/4-20x1 1/2"	3/4" Tube and Wire Clamp
1/4-20x1 1/2"	1/4-20x1 1/2"	1" Tube and Wire Clamp

- Organizes tubes and wires throughout your T-SLOTS design
- Attaches easily to T-Slot
- Mounts 1/8" through 1" O.D. tubing and wires
- Oil, chemical and acid resistant
- Stackable design
- 10 and 15 Series compatible

TSLOTS Hardware

TOOL HANGERS



ITEM #	DESCRIPTION
655095	10 S Tool Hanger 10S 25S
655096	15 S Tool Hanger 15S 40S

- Ideal for hanging air tools, cable reels, heavy door panels or transporting cables
- Slides into the extrusion end and moves easily in the T-Slot
- 10 and 15 Series sizes
- 100 lb. Capacity

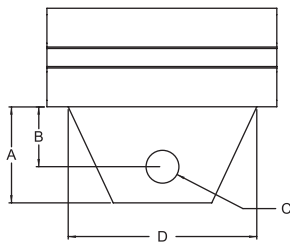

ITEM #	A	B	C	D
655095	1.10	.686	.328	2.00
655096	1.60	1.05	.500	3.00

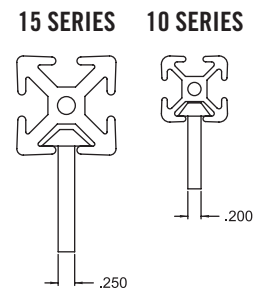

10 SERIES PRESSURE MANIFOLD PLATES 10S 25S

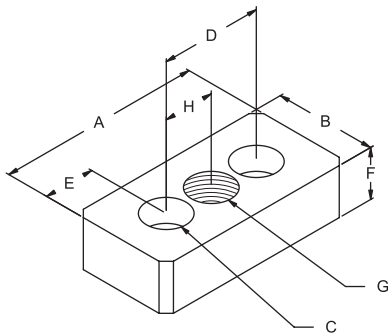

ITEM #	DESCRIPTION
655257	1" x 2" Blank Pressure Manifold Plate For Extrusion End
655300	1" x 2" 1/8" NPT Side Mount Pressure Manifold Plate
655141	1" x 2" 1/4" NPT End Mount Pressure Manifold Plate
655308	1" x 2" Blank Side Mount Pressure Manifold Plate
655303	1" x 3" Blank Pressure Manifold
655304	1" x 3" 1/4" NPT Blank Pressure Manifold
655258	2" x 2" Blank Pressure Manifold Plate For Extrusion End
655148	2" x 2" 3/8" NPT End Mount Pressure Manifold Plate

- Compatible with most fluids and gases
- Allows you to pressurize your machine
- 150 p.s.i. maximum pressure
- Item includes all fasteners and gaskets
- Contact us for custom manifolds

ITEM #	A	B	C	D	E	F	G	H
655257	2.00	1.00	DRILL THRU & C-BORE 1/4-20 SHCS	1.00	.500	.500	N/A	N/A
655300	2.00	1.00	DRILL THRU & C-BORE 1/4-20 SHCS	1.00	.500	.500	1/8"NPT	.500
655141	2.00	1.00	DRILL THRU & C-BORE 1/4-20 SHCS	1.00	.500	.500	1/4"NPT	.500
655303	3.00	1.00	DRILL THRU & C-BORE 1/4-20 SHCS	1.00	.500	.500	N/A	.500
655304	3.00	1.00	DRILL THRU & C-BORE 1/4-20 SHCS	1.00	.500	.500	1/4"NPT	.500
655308	2.00	1.00	DRILL THRU & C-BORE 1/4-20 SHCS	1.00	.500	.500	N/A	N/A
655258	2.00	2.00	DRILL THRU & C-BORE 1/4-20 SHCS	1.00	.500	.500	N/A	N/A
655300	2.00	2.00	DRILL THRU & C-BORE 1/4-20 SHCS	1.00	.500	.500	3/8"NPT	.500

15 SERIES PRESSURE MANIFOLD PLATES 15S



ITEM #	DESCRIPTION
655256	1.5" x 3" Blank Pressure Manifold Plate For Extrusion End
655307	1.5" x 3" Side Mount Blank Pressure Manifold Plate
655140	1.5" x 3" 3/8" NPT End Mount Pressure Manifold Plate
655302	1.5" x 3" 3/8" NPT Side Mount Pressure Manifold Plate
655301	1.5" x 3" 1/4" NPT Side Mount Pressure Manifold Plate
655150	1.5" x 4.5" Blank End Mount Pressure Manifold Plate
655151	1.5" x 4.5" 3/8" NPT End Mount Pressure Manifold Plate

» *Extrusion ends must be tapped a min of .75" for 10 Series and 1" deep for 15 Series.*

End mount is to be bolted on the end of the appropriate extrusion size and includes gasket and fasteners appropriate for end mounting. Most use one on each end of the extrusion.

Side mount is to be bolted on the side of the extrusion and includes O-ring gasket and fasteners. Bolts cannot be in the same slot. Requires a clearance hole in the center of extrusion to allow air to flow to manifold plate.

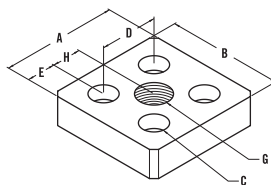
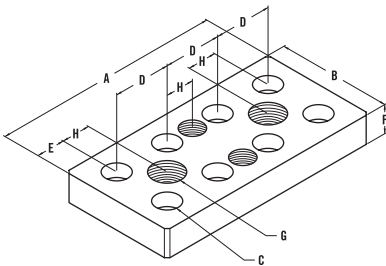

ITEM #	A	B	C	D	E	F	G	H
655256	3.00	1.50	DRILL THRU & C-BORE 5/16-18 SHCS	1.50	.750	.750	N/A	N/A
655307	3.00	1.50	DRILL THRU & C-BORE 5/16-18 SHCS	1.50	.750	.750	N/A	N/A
655140	3.00	1.50	DRILL THRU & C-BORE 5/16-18 SHCS	1.50	.750	.750	3/8"NPT	.750
655302	3.00	1.50	DRILL THRU & C-BORE 5/16-18 SHCS	1.50	.750	.750	3/8"NPT	.750
655301	3.00	1.50	DRILL THRU & C-BORE 5/16-18 SHCS	1.50	.750	.750	1/4"NPT	.750
655150	4.50	1.50	DRILL THRU & C-BORE 5/16-18 SHCS	1.50	.750	.750	N/A	N/A
655151	4.50	1.50	DRILL THRU & C-BORE 5/16-18 SHCS	1.50	.750	.750	3/8"NPT	N/A

- *Compatible with most fluids and gases*
- *Allows you to pressurize your machine*
- *150 p.s.i. maximum pressure*
- *Item includes all fasteners and gaskets*
- *Contact us for custom manifolds*

TSLOTS Hardware

REPLACEMENT GASKETS AND O-RINGS

GASKETS	ITEM #	SIZE	MATERIAL
	655142	1" x 2"	CR-20*
	655144	2" x 2"	CR-20*
	655143	1.5" x 3"	CR-20*
	655125	1.5" x 4.5"	CR-20*
	655145	3" x 3"	CR-20*
O-RINGS			
	655147	1" x 2"	RUBBER
	655146	1.5" x 3"	RUBBER

*CR-20 is a cork and synthetic rubber material manufactured by Global Technology Systems

SENSOR MOUNTING BLOCK 10S 15S 25S 40S



ITEM #	DESCRIPTION
655764	Sensor Mounting Block 10mm

- Attach sensors to TSLOTS profiles, fully adjustable
- Black, fiberglass reinforced nylon

RECOMMENDED FASTENERS

10 S	658588 & 651467	8-32 x 3/4" SHCS & Drop In T-Nut
15 S	658589 & 651642	8-32 x 1" SHCS & Drop In T-Nut

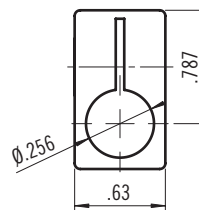
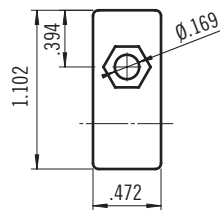

CLIP CABLE BINDER 15S 40S



ITEM #	DESCRIPTION
655765	15 S Nylon

RECOMMENDED FASTENERS

10 S	658590 & 651467	8-32 x 7/16" SHCS & Drop In T-Nut
15 S	658591 & 651642	8-32 x 5/8" SHCS & Drop In T-Nut

*Max cable diameter 0.5"

THREADED STEM SWIVEL CASTERS 10S 15S



ITEM #	DESCRIPTION
655231	1.62" Swivel Caster w/ 3/8-16 Stem w/o Brake
655232	2" Swivel Caster w/ 3/8-16 Stem w/ Brake
655233	3" Swivel Caster w/ 3/8-16 Stem w/ Brake
655237	4" Swivel Caster w/ 7/16-14 Stem w/ Brake
655234	4" Swivel Caster w/ 7/16-14 Stem w/ Brake
655235	5" Swivel Caster w/ 7/16-14 Stem w/ Brake
655236	5" Swivel Caster w/ 7/16-14 Stem w/ Brake

- Mounts directly to extrusion end or base plates
- 70-150 lb. Capacity
- 10 and 15 Series compatible

ITEM NUMBER	655231	655232	655233	655237	655234	655235	655236
DIAMETER	1.62"	2"	3"	4"	4"	5"	5"
CAPACITY	70 lbs	75 lbs	95 lbs	115 lbs	110 lbs	125 lbs	150 lbs
A	3/8-16 x 1.5"	3/8-16 x 1.5"	3/8-16 x 1.5"	7/16-14 x 1.5"	7/16-14 x 1.5"	7/16-14 x 1.5"	7/16-14 x 1.5"
B	2.15"	2.50"	3.50"	4.68"	4.563"	5.63"	5.63"
C	2.25"	2.60"	3.60"		4.75"	5.80"	5.80"
LOAD HEIGHT	2.25"	2.60"	3.60"	4.75"	4.75"	5.80"	5.80"
OIL RESISTANCE	Average	Average	Average	Average	Good	Average	Good
WHEEL COLOR	Black	Black	Black	Black	Black	Black	Black
LBS	.275	.333	.666	1.25	1.25	1.666	1.80
BRAKE	No	Yes	Yes	Yes	Yes	Yes	Yes
MOUNTING PLATE COMPATIBILITY	SEE PAGES 06:43 & 06:44 10 & 15 SERIES						

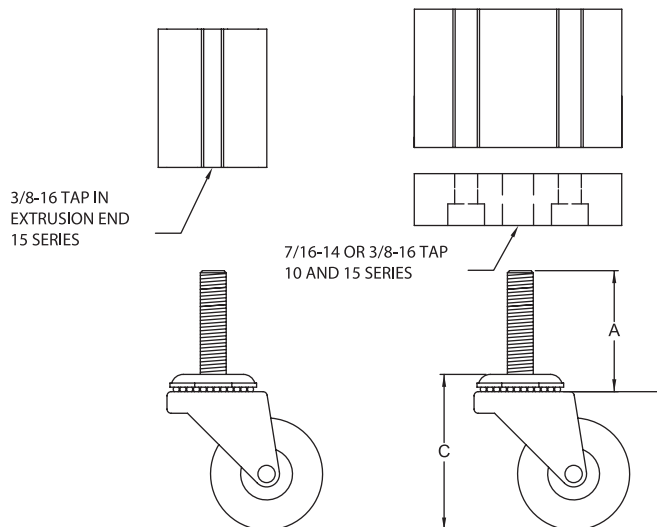

TSLOTS Hardware

FURNITURE STYLE CASTERS 10S 15S



ITEM #	DESCRIPTION
655225	3" Furniture Style Caster w/o Brake
655226	3" Furniture Style Caster w/ Brake
655227	4" Furniture Style Caster w/o Brake
655228	4" Furniture Style Caster w/ Brake
655229	5" Furniture Style Caster w/o Brake
655230	5" Furniture Style Caster w/ Brake

- Brake kits are optional on Furniture Style Casters
- 165 lb. to 265 lb. Capacity
- 10 and 15 Series compatible

ITEM NUMBER	655225	655226	655227	655228	655229	655230
DIAMETER	3"	3"	4"	4"	5"	5"
CAPACITY	165	165	225	225	265	265
A	2.85	2.85	3.93	3.93	4.92	4.92
B	3/8-16	3/8-16	3/8-16	3/8-16	1/2-13	1/2-13
C	4.40	4.40	5.82	5.82	6.73	6.73
D	1.00	1.00	1.00	1.00	1.00	1.00
E	0.944	0.944	1.37	1.37	1.37	1.37
F	3.66	3.66	4.88	4.88	5.75	5.75
LOAD HEIGHT	3.15	3.15	4.33	4.33	5.24	5.24
WHEEL COLOR	Black	Black	Black	Black	Black	Black
LBS	.570	.570	.827	.827	1.312	1.312
BRAKE	No	Yes	No	Yes	No	Yes
MOUNTING PLATE	SEE PAGES 06:43 & 06:44					
COMPATIBILITY	10 & 15 SERIES					

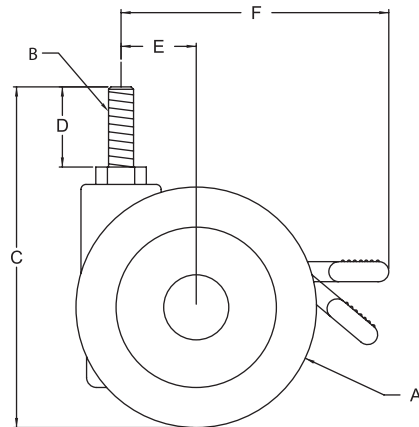

06:32

FLANGE MOUNT CASTERS 10S 15S 25S 40S



ITEM #	DESCRIPTION
655239	3" Flange Mount Rigid Caster w/o Brake
655241	4" Flange Mount Rigid Caster w/o Brake
655243	5" Flange Mount Rigid Caster w/o Brake
655245	3" Flange Mount Swivel Caster w/ Brake
655247	4" Flange Mount Swivel Caster w/ Brake
655249	5" Flange Mount Swivel Caster w/ Brake

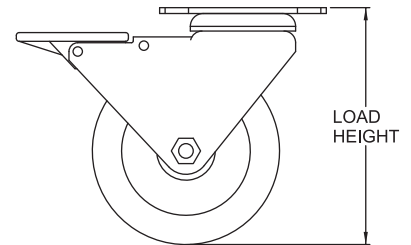

- Swivel and Rigid casters available
- Brake kits come standard on swivel casters
- 125 lb. to 285 lb. capacity
- 3", 4" and 5" diameters available

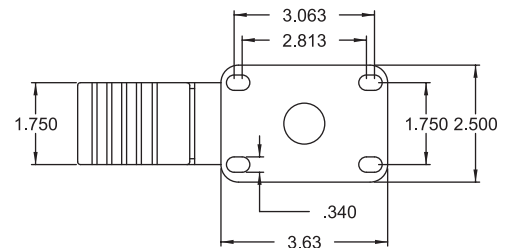

RIGID CASTERS

ITEM NUMBER	655239	655241	655243
DIAMETER	3"	4"	5"
CAPACITY	210 lbs	255 lbs	280 lbs
LOAD HEIGHT	3.82"	5.062"	6.062"
OIL RESISTANCE	Good	Good	Good
WHEEL COLOR	Black	Gray	Gray
LBS	1.50	2.00	2.50
BRAKES	No	No	No
MOUNTING PLATE	SEE PAGE 06:36		
MOUNTING BOLTS	(4)651050		

SWIVEL CASTERS

ITEM NUMBER	655245	655247	655249
DIAMETER	3"	4"	5"
CAPACITY	210 lbs	255 lbs	280 lbs
LOAD HEIGHT	3.82"	5.062"	6.062"
OIL RESISTANCE	Good	Good	Good
WHEEL COLOR	Black	Gray	Gray
LBS	1.50	2.50	3.00
BRAKES	Yes	Yes	Yes
MOUNTING PLATE	SEE PAGE 06:36		
MOUNTING BOLTS	(4)651050		

TSLOTS Hardware

TRIANGULAR TOP PLATE CASTERS 10S 15S 25S 40S



ITEM #	DESCRIPTION
655254	4" Triangular Top Plate Caster w/ Brake
655255	5" Triangular Top Plate Caster w/ Brake

- Triangular Top Plate mounts directly to extrusion
- Triangular Top Plate Caster features both swivel and wheel lock
- 4" caster has 250 lb. capacity – 5" caster has 275 lb. capacity
- 10 and 15 Series compatible

ITEM NUMBER	655254	655255
DIAMETER	4"	5"
CAPACITY	250	275
LOAD HEIGHT	5.75	6.75
WHEEL COLOR	Green	Green
LBS	2.805	2.91
PLATE THICKNESS	0.150"	0.100"

655254 RECOMMENDED FASTENERS

10 S	651235	1/4-20 x 1/2" FBHSCS & Economy T-Nut
15 S	651209	5/16-18 x 5/8" SHCS & Economy T-Nut

655255 RECOMMENDED FASTENERS

10 S	651235	1/4-20 x 1/2" FBHSCS & Economy T-Nut
15 S	651209	5/16-18 x 5/8" SHCS & Economy T-Nut

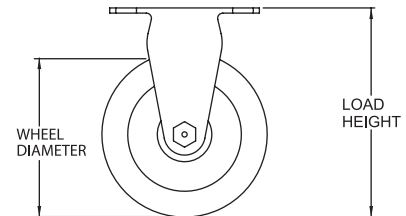
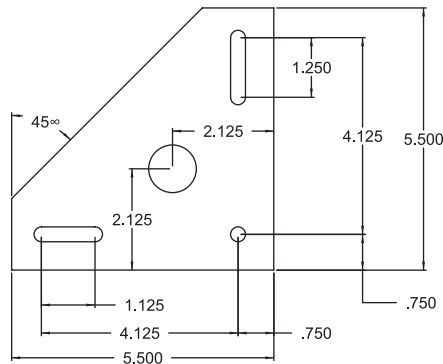

DELUXE FLANGE MOUNT CASTERS 10S 15S 25S 40S



ITEM #	DESCRIPTION
655250	4" Deluxe Flange Mount Swivel Caster w/ Brake
655251	5" Deluxe Flange Mount Swivel Caster w/ Brake
655252	4" Deluxe Flange Mount Rigid Caster w/o Brake
655253	5" Deluxe Flange Mount Rigid Caster w/o Brake

- Swivel and Rigid casters available
- Total Lock® brakes on all swivel casters – Press to lock – Press to unlock
- Mounts to TSLOTS with caster mount plates on page 06:35.
- Double ball hardened raceways
- Zerk fittings in wheel bearing
- 250 lb. capacity



SWIVEL CASTERS

ITEM NUMBER	655250	655251
DIAMETER	4"	5"
CAPACITY	250 lbs	250 lbs
LOAD HEIGHT	5.125"	6.187"
OIL RESISTANCE	Good	Good
WHEEL COLOR	Dark Red	Dark Red
LBS	2.50	3.25
BRAKES	Yes	Yes
MOUNTING PLATE	SEE PAGE 06:36	SEE PAGE 06:36
MOUNTING BOLTS	(4)651050	(4)651050

RIGID CASTERS

ITEM NUMBER	655252	655253
DIAMETER	4"	5"
CAPACITY	250 lbs	250 lbs
LOAD HEIGHT	5.125"	6.187"
OIL RESISTANCE	Good	Good
WHEEL COLOR	Dark Red	Dark Red
LBS	2.125	2.625
BRAKES	No	No
MOUNTING PLATE	SEE PAGE 06:36	SEE PAGE 06:36
MOUNTING BOLTS	(4)651050	(4)651050

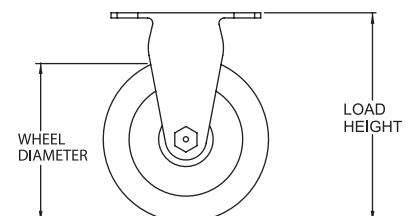
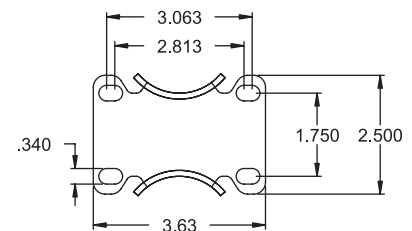
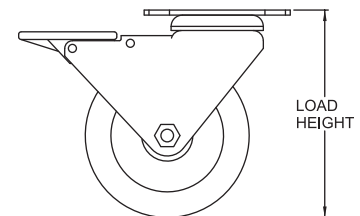
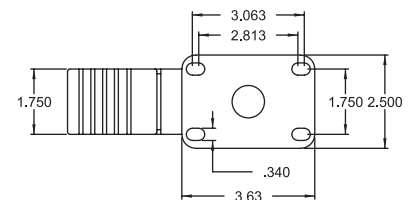

TSLOTS Hardware

FLANGE MOUNT CASTER BASE PLATE



ITEM #	DESCRIPTION
655279	10 S Flange Mount Caster Base Plate 10S 25S
655280	10 S Flange Mount Caster Base Plate 10S 25S
655281	15 S Flange Mount Caster Base Plate 15S
655287	15 S Flange Mount Caster Base Plate 15S

RECOMMENDED FASTENERS TO MOUNT TO EXTRUSION T-SLOT

BASE PLATE PART #	655279	655280	655281	655287
651205			4	4
651234	4	4		

RECOMMENDED FASTENERS TO MOUNT TO EXTRUSION END

BASE PLATE PART #	655279	655280	655281	655287
651059			4	4
651027	4	4		

- Mounts Flange Mount Caster and Deluxe Flange Mount Caster to extrusion
- Mount Base Plate to either extrusion end or slot
- 10 and 15 Series sizes

10 SERIES

ITEM #	655279	655280
A	2.50	2.50
B	.500	.500
C	3.75	3.75
D	2.94	2.94
E	.405	.405
F	.375	.375
G	1.75	1.75
H	1.375	1.375
J	1.00	1.00
L	.750	.750
LBS	.430	.430
M	5/16-18 TAP THRU	
N	DRILL THRU & C-BORE 1/4-20 SHCS	

15 SERIES

ITEM #	655281	655287
A	3.00	3.00
B	.750	.750
C	3.75	3.75
D	2.94	2.94
E	.405	.405
F	.625	.625
G	1.75	1.75
H	1.175	1.175
J	1.50	1.50
L	.750	.750
LBS	.755	.755
M	5/16-18 TAP THRU	
N	DRILL THRU & C-BORE 5/16-18 SHCS	

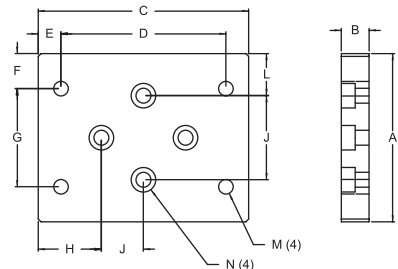
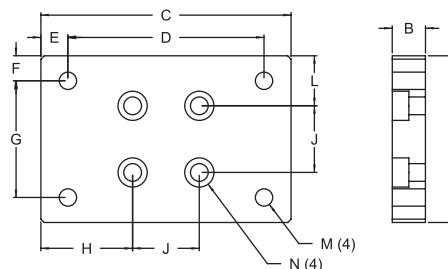

HEAVY DUTY FLANGE MOUNT CASTER PLATE 15S



ITEM #	DESCRIPTION
655137	Heavy Duty Flange Mount Caster Plate

RECOMMENDED FASTENERS TO MOUNT TO EXTRUSION T-SLOT

QTY	ITEM #
8	651205

RECOMMENDED FASTENERS TO MOUNT TO EXTRUSION END

QTY	ITEM #
8	651059

- Mount heavy duty casters to your TSLOTS frame
- Can mount on side or end of any 15 series extrusion
- Can also be used as a joining plate

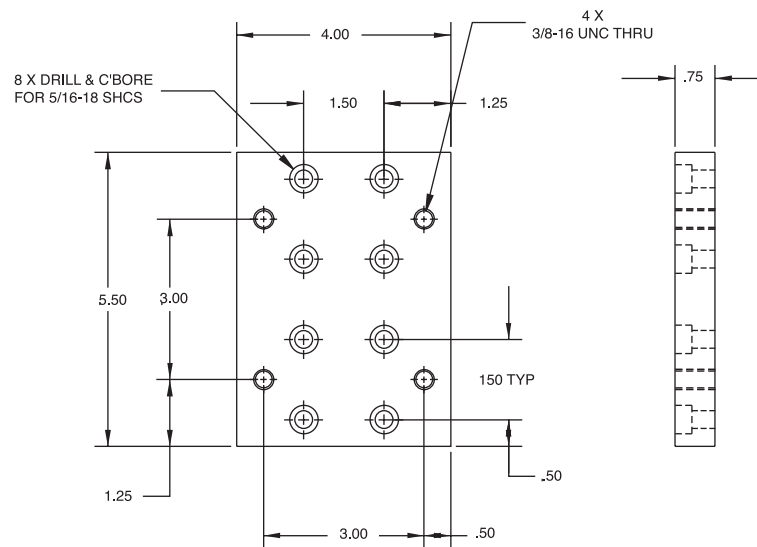

TSLOTS Hardware

HEAVY DUTY FLANGE MOUNT CASTERS ^{15S}



ITEM #	DESCRIPTION
655458	5" Heavy Duty Flange Mount Swivel Caster
655459	5" Heavy Duty Flange Mount Rigid Caster
655460	6" Heavy Duty Flange Mount Swivel Caster
655461	6" Heavy Duty Flange Mount Rigid Caster
655462	5" Heavy Duty Flange Mount Swivel Caster
655463	5" Heavy Duty Flange Mount Rigid Caster
655464	6" Heavy Duty Flange Mount Swivel Caster
655465	6" Heavy Duty Flange Mount Rigid Caster



- Swivel and Rigid casters available
- Comes in 5" and 6" diameters
- 425 lb. to 900 lb. capacity
- 15 Series compatible

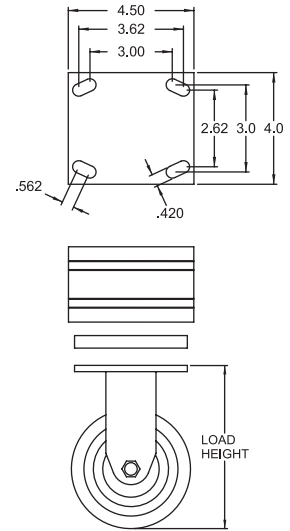

RIGID CASTERS

ITEM NUMBER	655459	655461	655463	655465
DIAMETER	5"	6"	5"	6"
CAPACITY	425 lbs	475 lbs	900 lbs	900 lbs
LOAD HEIGHT	6.5"	7.5"	6.5"	7.5"
OIL RESISTANCE	Average	Average	Good	Good
WHEEL COLOR	Black	Black	Dark Red	Dark Red
LBS	4.50	5.50	4.50	5.00
MOUNTING PLATE	SEE PAGE 06:37	SEE PAGE 06:37	SEE PAGE 06:37	SEE PAGE 06:37
MOUNTING BOLTS	(4)651062	(4)651062	(4)651062	(4)651062

SWIVEL CASTERS

ITEM NUMBER	655458	655460	655462	655464
DIAMETER	5"	6"	5"	6"
CAPACITY	425 lbs	475 lbs	750 lbs	900 lbs
LOAD HEIGHT	6.5"	7.5"	6.5"	7.5"
OIL RESISTANCE	Average	Average	Good	Good
WHEEL COLOR	Black	Black	Dark Red	Dark Red
LBS	5.50	7.00	5.00	6.00
MOUNTING PLATE	SEE PAGE 06:37	SEE PAGE 06:37	SEE PAGE 06:37	SEE PAGE 06:37
MOUNTING BOLTS	(4)651062	(4)651062	(4)651062	(4)651062

LARGE BASE GLIDES 10S 15S



ITEM #	DESCRIPTION
655167	3/8-16 Large Base Glide 1.97" Base
655168	1/2-13 Large Base Glide 1.97" Base
655165	3/8-16 Large Base Glide 3.15" Base
655166	1/2-13 Large Base Glide 3.15" Base

- 3/8-16 can mount directly into 15 S extrusion end
- Ideal for heavy duty frames
- Large Base diameter - Nylon

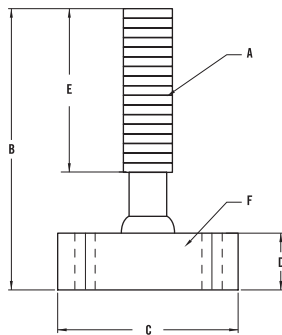

» See page 06:44 for 15 S Base Plates.

ITEM #	655167	655168	655165	655166
A	3/8-16	1/2-13	3/8-16	1/2-13
B	4.43	4.43	4.43	4.43
C	1.97	1.97	3.15	3.15
D	0.70	0.70	0.70	0.70
E	3.00	3.00	3.00	3.00
F	.256	.256	.354	.354
LOAD CAPACITY	4000 lbs	4000 lbs	5000 lbs	5000 lbs

LEVELING FEET 10S 15S



ITEM #	DESCRIPTION
655782	1/4-20 Economy Leveling Feet
655789	5/16-18 Economy Leveling Feet
655171	3/8-16 Economy Leveling Feet
655808	1/2-13 Economy Leveling Feet

- 3/8 - 16 Foot can mount directly into 15 S extrusion end
- Ideal for light duty machines, cabinets, workstations or office furniture
- Large base diameter - Nylon
- 10 and 15 Series sizes

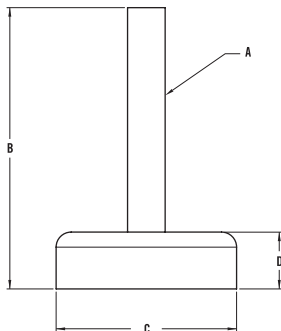

» Tap machining service required to load extrusion end. See page 11:06.

ITEM #	655782	655789	655171	655808
A	1/4-20	5/16-18	3/8-16	1/2-13
B	1.87	3.21	2.39	3.21
C	1.57	2.32	3.11	3.89
D	.708	.708	.708	.708
LOAD CAPACITY	460 lbs	770 lbs	1035 lbs	1035 lbs

TSLOTS Hardware

ECONOMY ANTI-VIBRATION MOUNT 10S 15S



ITEM #	DESCRIPTION
655185	3/8-16 Economy Anti-Vibration Mount
655186	1/2-13 Economy Anti-Vibration Mount
655187	3/4-10 Economy Anti-Vibration Mount

- Reduces vibration transmission
- Level high precision or computerized machinery
- Gold irridite finish
- Black rubber vibration pad
- Available in three sizes

» Tap machining service required to load extrusion end. See page 11:06.

ITEM #	655185	655186	655187
A	3/8-16	1/2-13	3/4-10
B	1.25	1.875	3.00
C	3.50	3.75	4.125
D	2.00	2.00	2.00
E	1.50	1.75	2.125
F	.562	.625	1.062
LOAD CAPACITY	100 lbs	240 lbs	650 lbs

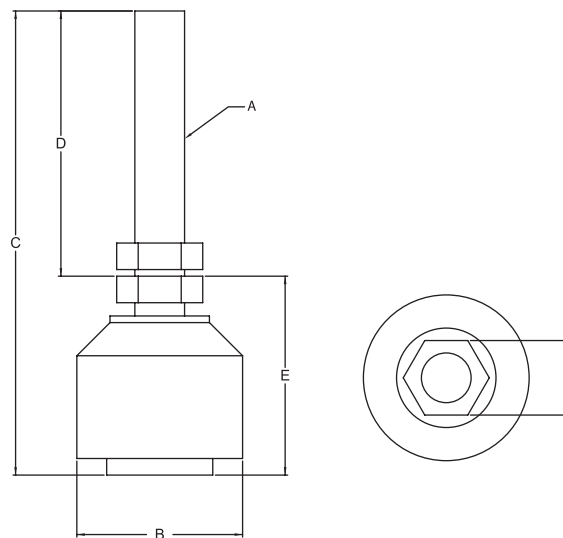

06:40

DELUXE LEVELING FEET 10S 15S



ITEM #	DESCRIPTION
655175	1/4-20 Deluxe Leveling Foot
655634	5/16-18 Deluxe Leveling Foot
655173	3/8-16 Deluxe Leveling Foot
655178	1/2-13 Deluxe Leveling Foot
655180	3/4-10 Deluxe Leveling Foot

- Threads directly into extrusion end or into 10 and 15 Series base plates
- Jam nut included
- Pivots 20 degrees to accommodate uneven floors
- 1000 lb. to 7400 lb. capacity
- 10 and 15 Series sizes



» Tap machining service required to load extrusion end. See page 11:06.

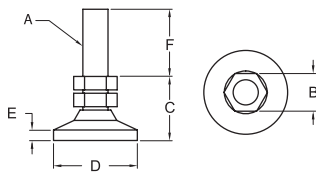

ITEM #	655175	655634	655173	655178	655180
A	1/4-20	5/16-18	3/8-16	1/2-13	3/4-10
B	.500	.630	.625	.750	1.062
C	.970	1.125	1.2	1.5	1.895
D	1.00	1.25	1.25	1.875	3.00
E	.156	.250	.188	.250	.500
F	1.00	1.78	1.71	1.61	1.56
LOAD CAPACITY	1000 lbs	2300 lbs	3750 lbs	5000 lbs	7400 lbs

DIE CAST LEVELING FEET 10S 15S



ITEM #	DESCRIPTION
655784	1/4-20 Die Cast Leveling Foot
655792	5/16-18 Die Cast Leveling Foot
655804	3/8-16 Die Cast Leveling Foot
655801	1/2-13 Die Cast Leveling Foot w/ Holes
655812	3/4-10 Die Cast Leveling Foot w/ Holes

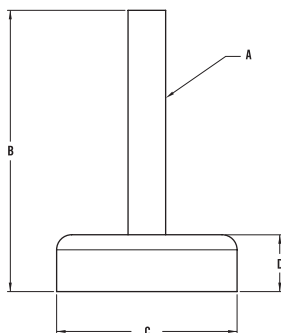

ITEM #	655784	655792	655804	655801	655812
A	1/4-20	5/16-18	3/8-16	1/2-13	3/4-10
B	1.87	3.21	2.39	3.21	3.71
C	1.57	2.32	3.11	3.11	3.89
D	.708	.708	.708	.708	.708
LOAD RATING	460 lbs	770 lbs	1035 lbs	1035 lbs	5300 lbs

TSLOTS Hardware

ECONOMY LEVELING FEET 10S 15S



ITEM #	DESCRIPTION
655176	1/4-20 Economy Leveling Foot
655177	5/16-18 Economy Leveling Foot
655174	3/8-16 Economy Leveling Foot
655179	1/2-13 Economy Leveling Foot

- Threads directly into extrusion end or into 10 and 15 Series base plates
- Jam nut included
- 1050 lb. to 4700 lb. capacity
- 10 and 15 Series sizes

» Tap machining service required to load extrusion end. See page 11:06.

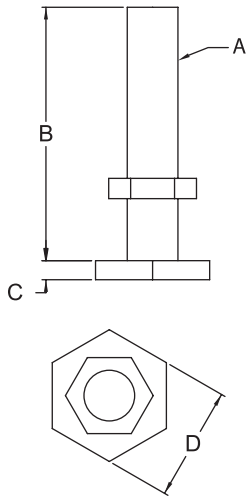

ITEM #	655176	655177	655174	655179
A	1/4-20	5/16-18	3/8-16	1/2-13
B	1.25	1.50	2.00	2.50
C	.094	.109	.141	.172
D	.563	.750	.875	1.063
LOAD CAPACITY	1050 lbs	1750 lbs	2550 lbs	7400 lbs

FLOOR BRACKET 15S 40S



ITEM #	DESCRIPTION
655766	Floor Bracket

- Adjustable height up to 2.83"

RECOMMENDED BOLT ASSEMBLY

QTY	ITEM #	DESCRIPTION
1	651201	5/16-18 x 5/8" SHCS & Economy T-Nut

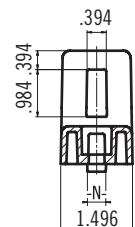
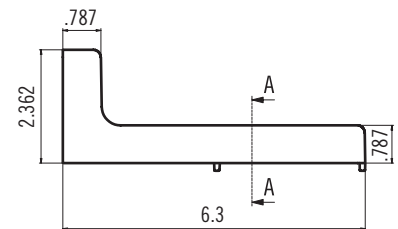

10 SERIES BASE PLATES 10S 15S

ITEM #	DESCRIPTION	BOLT KIT TO T SLOT	MOUNT IN EXTRUSION END
655120	10 S 1" x 2" Base Plate w/ 1/4-20 Tap In Center	(2) 651234	(2) 651027
659062	10 S 1" x 2" Base Plate w/ 5/16-18 Tap In Center	(2) 651234	(2) 651027
655121	10 S 1" x 2" Base Plate w/ 3/8-16 Tap In Center	(2) 651234	(2) 651027
655127	10 S 1" x 2" Base Plate w/ 7/16-14 Tap In Center	(2) 651234	(2) 651027
655260	10 S 1" x 2" Base Plate w/ 1/2-13 Tap In Center	(2) 651234	(2) 651027
655662	10 S 1" x 2" Base Plate Blank	(2) 651234	(2) 651027
655123	10 S 2" x 2" Base Plate w/ 3/8-16 Tap In Center	(4) 651234	(4) 651027
655129	10 S 2" x 2" Base Plate w/ 7/16-14 Tap In Center	(4) 651234	(4) 651027
655124	10 S 2" x 2" Base Plate w/ 1/2-13 Tap In Center	(4) 651234	(4) 651027
655261	10 S 2" x 2" Base Plate w/ 3/4-10 Tap In Center	(4) 651234	(4) 651027
655663	10 S 2" x 2" Base Plate Blank	(4) 651234	(4) 651027
655132	10 S 2" x 2" Base Plate w/ 3/8-16 Corner Tap	(3) 651234	N/A
655133	10 S 2" x 2" Base Plate w/ 7/16-14 Corner Tap	(3) 651234	N/A
655262	10 S 2" x 2" Base Plate w/ 1/2-13 Corner Tap	(3) 651234	N/A
655263	10 S 2" x 2" Base Plate w/ 3/4-10 Corner Tap	(3) 651234	N/A
655664	10 S 2" x 2" Corner Tap Base Plate Blank	(3) 651234	N/A

- Mounts leveling feet and threaded stem casters to T-SLOTS
- Bolts in extrusion end or in T-Slot
- See pages 06:39-06:42 for leveling feet
- See pages 06:31-06:32 for threaded stem casters

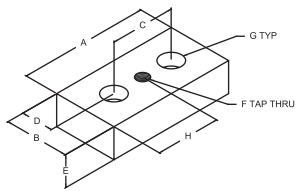

ITEM #	LBS	A	B	C	D	E	F	G	H
655120	.090	2.00	1.00	1.00	.500	.500	1/4-20	DRILL THRU & C-BORE FOR 1/4-20 SHCS	1.00
659062	.085	2.00	1.00	1.00	.500	.500	5/16-18	DRILL THRU & C-BORE FOR 1/4-20 SHCS	1.00
655121	.085	2.00	1.00	1.00	.500	.500	3/8-16	DRILL THRU & C-BORE FOR 1/4-20 SHCS	1.00
655127	.080	2.00	1.00	1.00	.500	.500	7/16-14	DRILL THRU & C-BORE FOR 1/4-20 SHCS	1.00
655260	.078	2.00	1.00	1.00	.500	.500	1/2-13	DRILL THRU & C-BORE FOR 1/4-20 SHCS	1.00
655662	.090	2.00	1.00	1.00	.500	.500	N/A	DRILL THRU & C-BORE FOR 1/4-20 SHCS	1.00

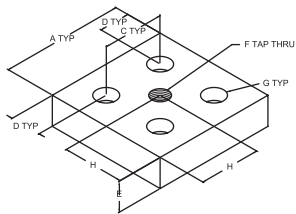

ITEM #	LBS	A	B	C	D	E	F	G	H
655123	.175	2.00	N/A	1.00	.500	.500	3/8-16	DRILL THRU & C-BORE FOR 1/4-20 SHCS	1.00
655129	.170	2.00	N/A	1.00	.500	.500	7/16-14	DRILL THRU & C-BORE FOR 1/4-20 SHCS	1.00
655124	.170	2.00	N/A	1.00	.500	.500	1/2-13	DRILL THRU & C-BORE FOR 1/4-20 SHCS	1.00
655261	.160	2.00	N/A	1.00	.500	.500	3/4-10	DRILL THRU & C-BORE FOR 1/4-20 SHCS	1.00
655663	.180	2.00	N/A	1.00	.500	.500	N/A	DRILL THRU & C-BORE FOR 1/4-20 SHCS	N/A

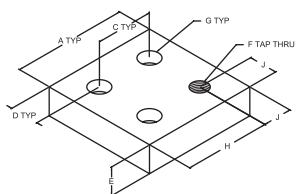

ITEM #	LBS	A	B	C	D	E	F	G	H	J
655132	.180	2.00	N/A	1.00	.500	.500	3/8-16	DRILL THRU & C-BORE FOR 1/4-20 SHCS	1.50	.500
655133	.175	2.00	N/A	1.00	.500	.500	7/16-14	DRILL THRU & C-BORE FOR 1/4-20 SHCS	1.50	.500
655262	.172	2.00	N/A	1.00	.500	.500	1/2-13	DRILL THRU & C-BORE FOR 1/4-20 SHCS	1.50	.500
655263	.170	2.00	N/A	1.00	.500	.500	3/4-10	DRILL THRU & C-BORE FOR 1/4-20 SHCS	1.50	.500
655664	.185	2.00	N/A	1.00	.500	.500	N/A	DRILL THRU & C-BORE FOR 1/4-20 SHCS	N/A	N/A

TSLOTS Hardware

15 SERIES BASE PLATES 15S

ITEM #	DESCRIPTION	BOLT KIT TO T SLOT	MOUNT IN EXTRUSION END
655122	15 S 1.5" x 3" Base Plate w/ 3/8-16 Tap In Center	(2) 651205	(2) 651059
655128	15 S 1.5" x 3" Base Plate w/ 7/16-14 Tap In Center	(2) 651205	(2) 651059
655126	15 S 1.5" x 3" Base Plate w/ 1/2-13 Tap In Center	(2) 651205	(2) 651059
655264	15 S 1.5" x 3" Base Plate w/ 3/4-10 Tap In Center	(2) 651205	(2) 651059
655658	15 S 1.5" x 3" Base Plate Blank	(2) 651205	(2) 651059
655135	15 S 3" x 3" Base Plate w/ 7/16-14 Tap In Center	(4) 651205	(4) 651059
655130	15 S 3" x 3" Base Plate w/ 1/2-13 Tap In Center	(4) 651205	(4) 651059
655265	15 S 3" x 3" Base Plate w/ 3/4-10 Tap In Center	(4) 651205	(4) 651059
655659	15 S 3" x 3" Base Plate Blank	(4) 651205	(4) 651059
655136	15 S 3" x 3" Base Plate w/ 7/16-14 Corner Tap	(3) 651205	N/A
655131	15 S 3" x 3" Base Plate w/ 1/2-13 Corner Tap	(3) 651205	N/A
655266	15 S 3" x 3" Base Plate w/ 3/4-10 Corner Tap	(3) 651205	N/A
655665	15 S 3" x 3" Corner Tap Base Plate Blank	(3) 651205	N/A
655660	15 S 1.5" x 4.5" Base Plate Blank	(3) 651205	(3) 651059

- Mounts leveling feet and threaded stem casters to TSLOTS
- Bolts in extrusion end or in T-Slot
- See pages 06:39-06:42 for leveling feet
- See pages 06:31-06:32 for threaded stem casters

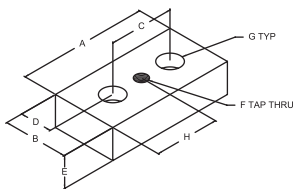

ITEM #	LBS	A	B	C	D	E	F	G	H
655122	.300	3.00	1.50	1.50	.750	.750	3/8-16	DRILL THRU & C-BORE FOR 5/16-18 SHCS	1.50
655128	.300	3.00	1.50	1.50	.750	.750	7/16-14	DRILL THRU & C-BORE FOR 5/16-18 SHCS	1.50
655126	.300	3.00	1.50	1.50	.750	.750	1/2-13	DRILL THRU & C-BORE FOR 5/16-18 SHCS	1.50
655264	.286	3.00	1.50	1.50	.750	.750	3/4-10	DRILL THRU & C-BORE FOR 5/16-18 SHCS	1.50
655658	.305	3.00	1.50	1.50	.750	.750	N/A	DRILL THRU & C-BORE FOR 5/16-18 SHCS	N/A

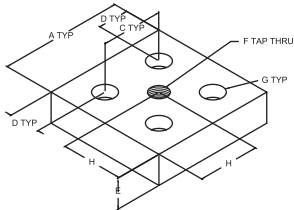



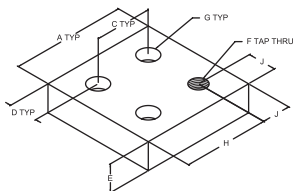





ITEM #	LBS	A	B	C	D	E	F	G	H
655135	.600	3.00	N/A	1.50	.750	.750	7/16-14	DRILL THRU & C-BORE FOR 5/16-18 SHCS	1.50
655130	.600	3.00	N/A	1.50	.750	.750	1/2-13	DRILL THRU & C-BORE FOR 5/16-18 SHCS	1.50
655265	.580	3.00	N/A	1.50	.750	.750	3/4-10	DRILL THRU & C-BORE FOR 5/16-18 SHCS	1.50
655659	.610	3.00	N/A	1.50	.750	.750	N/A	DRILL THRU & C-BORE FOR 5/16-18 SHCS	N/A



ITEM #	LBS	A	B	C	D	E	F	G	H	J
655136	.750	3.00	N/A	1.50	.750	.750	7/16-14	DRILL THRU & C-BORE FOR 5/16-18 SHCS	1.50	2.25
655131	.750	3.00	N/A	1.50	.750	.750	1/2-13	DRILL THRU & C-BORE FOR 5/16-18 SHCS	1.50	2.25
655266	.730	3.00	N/A	1.50	.750	.750	3/4-10	DRILL THRU & C-BORE FOR 5/16-18 SHCS	1.50	2.25
655665	.770	3.00	N/A	1.50	.750	.750	N/A	DRILL THRU & C-BORE FOR 5/16-18 SHCS	N/A	N/A

BASE PLATES - FLOOR MOUNT



ITEM #	DESCRIPTION	BOLT KIT TO MOUNT TO T-SLOT
655267	10 S 1010 Floor Mount Base Plate  	(4) 651130
655268	10 S 1020 Floor Mount Base Plate  	(8) 651130
655269	10 S 2020 Floor Mount Base Plate  	(8) 651130
655270	15 S 1515 Floor Mount Base Plate 	(4) 651129
655271	15 S 1530 Floor Mount Base Plate 	(8) 651129
655274	15 S 3030 Floor Mount Base Plate 	(8) 651129

- Very strong method of mounting your frame to the floor
- Bolts directly in the T-Slot
- Allows for vertical adjustments
- Slotted base plate holes allow for lateral adjustments
- 10 and 15 Series sizes

ITEM #	655267	655268	655269	655270	655271	655274
A	4.00	5.50	5.50	5.00	6.00	6.00
B	5.50	5.50	6.50	6.00	6.50	8.00
C	4.25	4.25	5.25	4.75	5.25	6.75
D	2.75	4.25	4.25	3.75	4.75	4.75
E	1.00	2.00	2.00	1.50	3.00	3.00
F	2.25	2.25	3.25	2.75	3.25	4.75
G	1.00	1.00	2.00	1.50	1.50	3.00
H	1.00	1.00	1.00	1.00	1.00	1.00
J	0.25	.250	.250	.250	.250	.250
L	.406	.406	.406	.531	.531	.531
M	2.75	2.75	2.75	2.75	2.75	2.75
N	N/A	1.00	1.00	N/A	1.50	1.50
P	1.50	1.50	1.50	1.50	1.50	1.50
R	.500	.500	.500	.750	.750	.750
S	.281	.281	.281	.328	.328	.328
T	5.00	5.00	5.00	5.00	5.00	5.00
U	.250	.250	.250	.375	.375	.375
V	.750	.750	.750	.750	.750	.750
LBS	.870	1.555	1.570	1.555	2.445	2.770

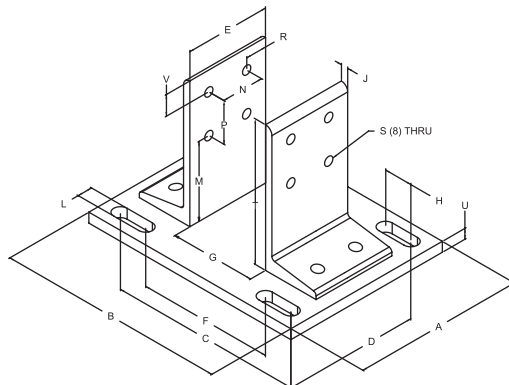

TSLOTS Hardware

BASE PLATES - FLOOR MOUNT 10 SERIES ECONOMY 10S 25S



655275

ITEM #	DESCRIPTION	BOLT KIT TO MOUNT TO TSLOT
655275	10 S 1" Economy Floor Mount Base Plate	(2) 651130
655277	10 S 2" Economy Floor Mount Base Plate	(4) 651130
655272	10 S 3" Economy Floor Mount Base Plate	(6) 651130

- Strong economy base plates
- Bolts directly in the T-Slot
- Allows vertical adjustments
- More economical than standard Floor Mount Base Plate



655277

ITEM #	655275	655277	655272
A	5.00	5.00	5.00
B	2.75	2.75	2.75
C	1.50	1.50	1.50
D	N/A	1.00	1.00
E	.250	.250	.250
F	2.00	2.00	2.00
G	.688	.688	.688
H	N/A	1.00	1.00
J	1.00	2.00	3.00
K	.257	.257	.257
L	.390	.390	.390
M	.875	.875	.875
N	.500	.500	.500
LBS	.175	.350	.525



655272

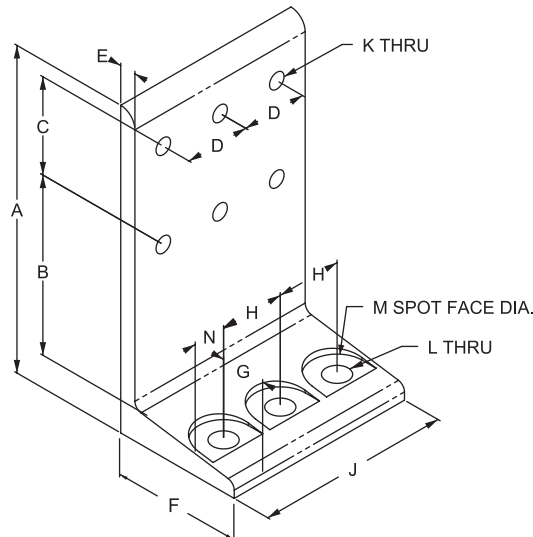

06:46

BASE PLATES - FLOOR MOUNT 15 SERIES ECONOMY



655276

ITEM #	DESCRIPTION	BOLT KIT TO MOUNT TO T SLOT
655276	15 S 1.5" Economy Floor Mount Base Plate	(2) 651129
655278	15 S 3" Economy Floor Mount Base Plate	(4) 651129
655273	15 S 4.5" Economy Floor Mount Base Plate	(6) 651129

- Strong economy base plates
- Bolts directly in the T-Slot
- Allows vertical adjustments
- More economical than standard Floor Mount Base Plate



655278

ITEM #	655276	655278	655273
A	5.00	5.00	5.00
B	2.75	2.75	2.75
C	1.50	1.50	1.50
D	N/A	1.50	1.50
E	.250	.250	.250
F	2.00	2.00	2.00
G	.688	.688	.688
H	N/A	1.50	1.50
J	1.50	3.00	4.50
K	.328	.328	.328
L	.531	.531	.531
M	1.125	1.125	1.125
N	.750	.750	.750
LBS	.265	.530	.795



655273

